



User Manual

FGW4148-16S/32S/48S

Contents

About This User Guide	1
Contacting FlyingVoice	2
Purpose	3
Cross references	3
Feedback	3
Declaration of Conformity	4
Part 15 FCC Rules	4
Warnings and Notes	5
Warnings	5
Notes	5
Chapter 1 Product description	6
FGW4148-16S/32S/48S	7
LED Indicators and Interfaces	8
FGW4148-16S	8
FGW4148-32S	9
FGW4148-48S	10
Hardware Installation	11
Chapter 2 IVR Voice Prompt	13
Voice adapter Configuration Method (IVR)	14
Start IVR	14
IVR Description	14
Chapter 3 Basic Settings	20
WEB Page	21
About Password	21
URL Format	21
WEB Interface Introduction	23
SIP Account Register	24
Register one by one	24
Batch Registration	25
Basic Function	26
Calling phone or extension numbers	26

Direct IP calls 26
 Call Hold 27
 Call transfer 27
 Conference 28

Chapter 4 Web Interface 29

Login 30
 Status 31
 Network 31
 WAN 31
 LAN 38
 VPN 39
 DMZ 41
 MAC Clone 42
 Port Setting 42
 Routing 43
 SIP Account 44
 Account 44
 FXS Settings 45
 SIP Settings 50
 VoIP QoS 50
 Phone 52
 Preferences 52
 Dial Rule 56
 Call Log 57
 Administration 58
 Management 58
 Firmware Upgrade 63
 Scheduled Tasks 63
 Provision 64
 SNMP 66
 TR-069 66
 Diagnosis 68
 Operating Mode 69
 System Log 69
 Logout 70
 Reboot 70

About This User Guide 1

Contacting FlyingVoice	2
Purpose	3
Cross references	3
Feedback	3
Declaration of Conformity	4
Part 15 FCC Rules	4
Warnings and Notes	5
Warnings	5
Notes	5
Chapter 1 Product description	6
FGW4148-16S/32S/48S	7
LED Indicators and Interfaces	8
FGW4148-16S	8
FGW4148-32S	9
FGW4148-48S	10
Hardware Installation	11
Chapter 2 IVR Voice Prompt	13
Voice adapter Configuration Method (IVR)	14
Start IVR	14
IVR Description	14
Chapter 3 Basic Settings	20
WEB Page	21
About Password	21
URL Format	21
WEB Interface Introduction	23
SIP Account Register	24
Register one by one	24
Batch Registration	25
Basic Function	26
Calling phone or extension numbers	26
Direct IP calls	26
Call Hold	27
Call transfer	27
Conference	28
Chapter 4 Web Interface	29

Login	30
Status	31
Network	31
WAN	31
LAN	38
VPN	39
DMZ	41
MAC Clone	42
Port Setting	42
Routing	43
SIP Account	44
Account	44
FXS Settings	45
SIP Settings	50
VoIP QoS	50
Phone	52
Preferences	52
Dial Rule	56
Call Log	57
Administration	58
Management	58
Firmware Upgrade	63
Scheduled Tasks	63
Provision	64
SNMP	66
TR-069	66
Diagnosis	68
Operating Mode	69
System Log	69
Logout	70
Reboot	70
Chapter 5 IPv6 address configuration	71
Introduction	72
IPv6 Advance	73
Configuring IPv6	75
Viewing WAN port status	75
LAN DHCPv6	76

Chapter 6 Troubleshooting Guide 80

- Configuring PC to get IP Address automatically 81
- Cannot connect to the Web 82
- Forgotten Password 82

Table

Table 1 Features at-a-glance	7
Table 2 FGW4148-16S Front panel	8
Table 3 FGW4148-16S Rear panel	8
Table 4 FGW4148-32S Front panel	9
Table 5 FGW4148-32S Rear panel	9
Table 6 FGW4148-48S Front panel	10
Table 7 FGW4148-48S Rear panel	10
Table 8 IVR Menu Setting Options	15
Table 9 WEB Interface Introduction	23
Table 10 Config SIP the Web Management Interface	24
Table 11 Login details	30
Table 12 Static IP	32
Table 13 DHCP	33
Table 14 PPPoE	34
Table 15 Bridge Mode	36
Table 16 LAN port	38
Table 17 PPTP	39
Table 18 L2TP	40
Table 19 OpenVPN	41
Table 20 DMZ	41
Table 21 MAC Clone	42
Table 22 Port setting	42
Table 23 Routing	43
Table 24 Line	45
Table 25 Audio configuration	46
Table 26 Supplementary service	47
Table 27 Advanced	47
Table 28 SIP Settings	50
Table 29 VoIP QoS	51
Table 30 Preferences	52
Table 31 Regional	52
Table 32 Features and call forward	54

Table 33	Miscellaneous	55
Table 35	Dial Plan Syntactic	56
Table 36	Call log	57
Table 37	Save Config File	58
Table 38	Administrator settings	59
Table 39	NTP settings	60
Table 40	Daylight Saving Time	61
Table 41	System log Setting	61
Table 42	Factory Defaults Setting	62
Table 43	Factory Defaults	62
Table 44	Firmware upgrade	63
Table 45	Scheduled Tasks	63
Table 46	Provision	64
Table 47	Firmware Upgrade	65
Table 48	SNMP	66
Table 49	TR069	67
Table 50	Diagnosis	68
Table 51	Operating mode	69
Table 52	System log	69
Table 53	Logout	70

About This User Guide

Thanks for choosing FGW4148-16S/32S/48S router with VoIP. This product will allow you to make ATA call using your broadband connection.

This manual provides basic information on how to install and connect FGW4148-16S/32S/48S router with VoIP to the Internet. It also includes features and functions of router with VoIP components, and how to use it correctly.

Before you can connect FGW4148-16S/32S/48S to the Internet and use it, you must have a high-speed broadband connection installed. A high-speed connection includes environments such as DSL, cable modem, and a leased line.

FGW4148-16S/32S/48S router with VoIP is a stand-alone device, which requires no PC to make Internet calls. This product guarantees clear and reliable voice quality on Internet, which is fully compatible with SIP industry standard and able to interoperate with many other SIP devices and software on the market.



This guide contains the following chapters:

- [Chapter 1 Product description](#)
- [Chapter 2 IVR Voice Prompt](#)
- [Chapter 3 Basic Settings](#)
- [Chapter 4 Web Interface](#)
- [Chapter 5 Troubleshooting Guide](#)

Contacting FlyingVoice

Main website: <http://www.flyingvoice.com/>

Sales enquiries: sales1@flyingvoice.com

Support enquiries: support@flyingvoice.com

Hotline: 010-67886296 0755-26099365

Address: Room508-509, Bldg#1, Dianshi Business Park, No.49 BadachuRd,Shijingshan
District, Beijing, China

Purpose

The documents are intended to instruct and assist personnel in the operation, installation and maintenance of the FlyingVoice equipment and ancillary devices. It is recommended that all personnel engaged in such activities be properly trained. FlyingVoice disclaims all liability whatsoever, implied or express, for any risk of damage, loss or reduction in system performance arising directly or indirectly out of the failure of the customer, or anyone acting on the customer's behalf, to abide by the instructions, system parameters, or recommendations made in this document.

Cross references

References to external publications are shown in italics. Other cross references, emphasized in blue text in electronic versions, are active links to the references.

This document is divided into numbered chapters that are divided into sections. Sections are not numbered, but are individually named at the top of each page, and are listed in the table of contents.

Feedback

We appreciate feedback from the users of our documents. This includes feedback on the structure, content, accuracy, or completeness of our documents. Send feedback to support@flyingvoice.com.

Declaration of Conformity

Part 15 FCC Rules

This device complies with Part 15 of the FCC Rules. Operation is subject to the following two conditions:

- This device may not cause harmful interference, and
- This device must accept any interference received, including interference that may cause undesired operation.

Class B Digital Device or Peripheral

This equipment has been tested and found to comply with the limits for a Class B digital device, pursuant to Part 15 of the FCC Rules. These limits are designed to provide reasonable protection against harmful interference in a residential installation. This equipment can generate, use and radiate radio frequency energy. If not installed and used in accordance with the instruction manual, may cause harmful interference to radio communications. However, there is no guarantee that interference does not occur in a particular installation.



Notes

Changes or modifications not expressly approved by the party responsible for compliance could void the user's authority to operate the equipment.

If this equipment does cause harmful interference to radio or television reception, which can be determined by turning the equipment off and on, the user is encouraged to try to correct the interferences by one or more of the following measures:

- Reorient or relocate the receiving antenna.
- Increase the separation between the equipment and receiver.
- Connect the equipment into an outlet on a circuit different from that to which the receiver is connected.
- Consult the dealer or an experienced radio/TV technician for help.

Warnings and Notes

The following describes how warnings and notes are used in this document and in all documents of the FlyingVoice document set.

Warnings

Warnings precede instructions that contain potentially hazardous situations. Warnings are used to alert the reader to possible hazards that could cause loss of life or physical injury. A warning has the following format:



Warning

Warning text and consequence for not following the instructions in the warning.

Notes

A note means that there is a possibility of an undesirable situation or provides additional information to help the reader understand a topic or concept. A note has the following format:



Notes

Notes text and consequence for not following the instructions in the Notes.



Chapter 1 Product description

This chapter covers:

- [FGW4148-16S/32S/48S](#)
- [LED Indicators and Interfaces](#)
- [Hardware Installation](#)

FGW4148-16S/32S/48S

Table 1 Features at-a-glance

Port/Model	FWG4148-16S	FWG4148-32S	FWG4148-48S
picture			
Ethernet interface	2*RJ45 10/100/1000M (WAN/LAN)	2*RJ45 10/100/1000M (WAN/LAN)	2*RJ45 10/100/1000M (WAN/LAN)
FXS	16	32	48
SIP Account	16	32	48
Wire-speed NAT	Support	Support	Support
DHCP	Client/Server	Client/Server	Client/Server
Voice Code	G.711 (A-law, U-law), G.729A/AB,G.723,G.722		
Management	Voice menu, Web Management, Provision:TFTP/HTTP/HTTPS, TR069, SNMP		
Fax	T.30, T.38 Fax		

LED Indicators and Interfaces

FGW4148-16S

Table 2 FGW4148-16S Front panel

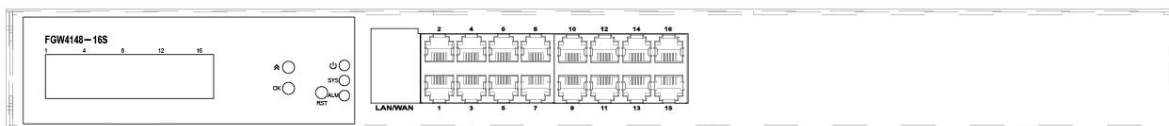

LED/Interface	Status	Description
LED		
LED Screen		The screen will appear the information about the device
	On(Green)	The router is powered on and running normally.
	Off	The router is powered off.
	Blinking(Green)	The router is updating
	on	The router is running normally.
		When the light is on, it indicates system applications occurred
Ethernet interface indicator	Blinking(Green)	Have data transmission
	on	The system is not powered on or the network port is not connected to the network device
Interface		
		Page up, can view info of FXS status.
		Use OK to return to the standby page
		Press it to restore factory settings above 5S
LAN		Connector for local network devices
WAN		Connector for accessing the internet
PHONE 1-16		Connect to the phone

Table 3 FGW4148-16S Rear panel

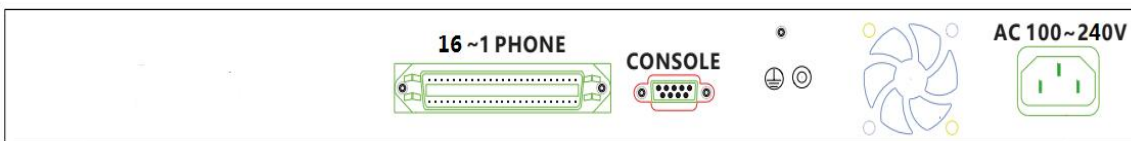

Interface	Description
16-1 PHONE	Transfer interface for 1-16 FXS
CONSOLE	Serial port,used to connect to your PC
Ground	Connect the ground wire
Fan	For equipment cooling

AC 100~220V Connector for a power adapter.

FGW4148-32S

Table 4 FGW4148-32S Front panel

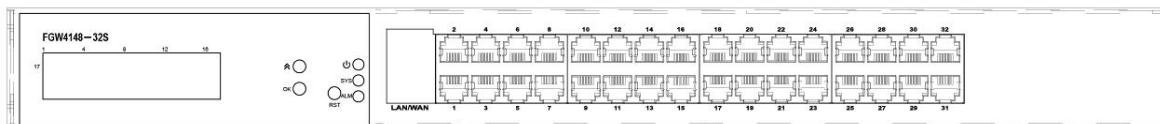







LED/Interface	Status	Description
LED		
LED Screen		The screen will appear the information about the device
	On(Green)	The router is powered on and running normally.
	Off	The router is powered off.
	Blinking(Green)	The router is updating
	on	The router is running normally.
		When the light is on, it indicates system applications occurred
Ethernet interface indicator	Blinking(Green)	Have data transmission
	on	The system is not powered on or the network port is not connected to the network device
Interface		
		Page up, can view info of FXS status.
		Use OK to return to the standby page
		Press it to restore factory settings above 5S
LAN		Connector for local network devices
WAN		Connector for accessing the internet
PHONE 1-16		Connect to the phone

Table 5 FGW4148-32S Rear panel



Interface	Description
32-26 PHONE	Transfer interface for 26-32 FXS
25-1 PHONE	Transfer interface for 1-25 FXS
CONSOLE	Serial port,used to connect to your PC

Ground	Connect the ground wire
Fan	For equipment cooling
AC 100~220V	Connector for a power adapter.

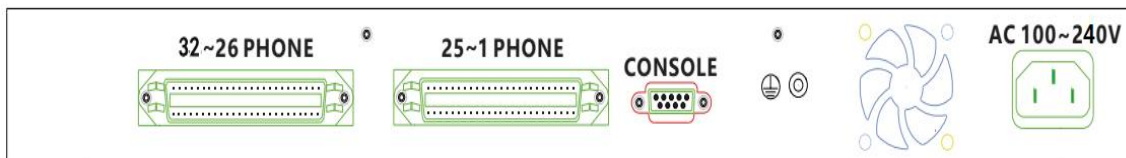
FGW4148-48S

Table 6 FGW4148-48S Front panel

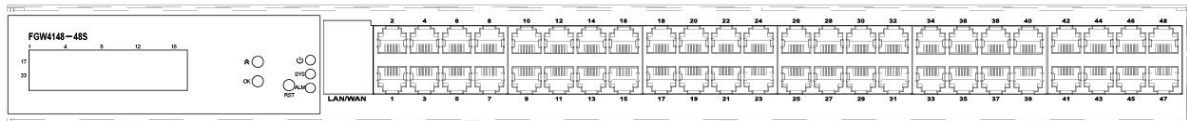







LED/Interface	Status	Description
LED		
LED Screen		The screen will appear the information about the device
	On(Green)	The router is powered on and running normally.
	Off	The router is powered off.
	Blinking(Green)	The router is updating
	on	The router is running normally.
		When the light is on, it indicates system applications occurred
Ethernet interface indicator	Blinking(Green)	Have data transmission
	on	The system is not powered on or the network port is not connected to the network device
Interface		
		Page up, can view info of FXS status.
		Use OK to return to the standby page
		Press it to restore factory settings above 5S
LAN		Connector for local network devices
WAN		Connector for accessing the internet
PHONE 1-16		Connect to the phone

Table 7 FGW4148-48S Rear panel



Interface	Description
48-26 PHONE	Transfer interface for 26-48 FXS
25-1 PHONE	Transfer interface for 1-25 FXS

CONSOLE	Serial port,used to connect to your PC
Ground	Connect the ground wire
Fan	For equipment cooling
AC 100~220V	Connector for a power adapter.

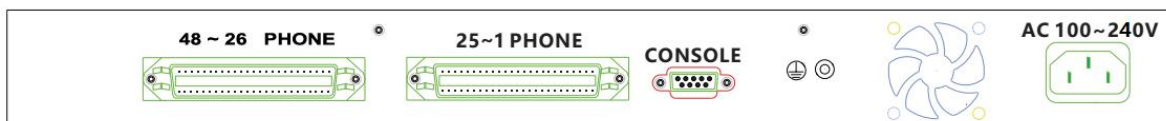
Hardware Installation

Before configuring your router, please see the procedure below for instructions on connecting the device in your network.

Procedure 1 Configuring the Router

1. Connect analog phone to ATA Port with an RJ11 cable.
2. Connect the WAN port to the Internet your network's modem/switch/router/ADSL
3. equipment using an Ethernet cable.
4. Connect one end of the power cord to the power port of the device. Connect the other end to the wall outlet.
5. Check the Power, WAN, and LAN LED to confirm network connectivity.

Warning



Please do not attempt to use unsupported power adapters and do not remove power during configuring or updating the device. Using other power adapters may damage

FGW4148-16S/32S/48S and will void the manufacturer warranty.

Warning

Changes or modifications not expressly approved by the party responsible for compliance can void the user's authority to operate the equipment.

This equipment has been tested and found to comply with the limits for a Class B digital device, pursuant to Part 15 of the FCC Rules. These limits are designed to provide reasonable protection against harmful interference in a residential installation. This equipment generates, uses and can radiate radio frequency cause harmful interference to radio communications. However, there is no energy and, if not installed and used in accordance with the instructions, may guarantee that interference will not occur in a particular installation.

If this equipment does cause harmful interference to radio or television reception, which can be determined by turning the equipment off and on, the user is encouraged to try to correct the interference by one or more of the following measures:

- Reorient or relocate the receiving antenna.
 - Increase the separation between the equipment and receiver.
 - Connect the equipment into an outlet on a circuit different from that to which the receiver is connected.
-

Chapter 2 IVR Voice Prompt

This chapter contains:

- [Voice adapter Configuration Method \(IVR\)](#)
- [IVR description](#)

Voice adapter Configuration Method (IVR)

The device can be configured in two ways, as follows:

- (1) Use IVR (Interactive Voice Response)
- (2) the use of web pages

This chapter mainly introduces how to configure the voice adapter through IVR.

Start IVR

Users follow these steps to achieve IVR:

- (1) Go off-hook and press the "****" key to start the IVR. Then the user will hear the voice prompt "1 WAN port configuration...".
- (2) According to different options, press any digit between 0 and 9, the device will broadcast the corresponding content, the numbers 0 to 9 represent the details as shown in the chart below.
- (3) After each setting is successful, the device will play "Please input option, 1 WAN port configuration...".



Note

Before using IVR, please confirm analog phone is connected with ATA correctly.

IVR Description

The following chart lists the IVR requirements and a detailed description:

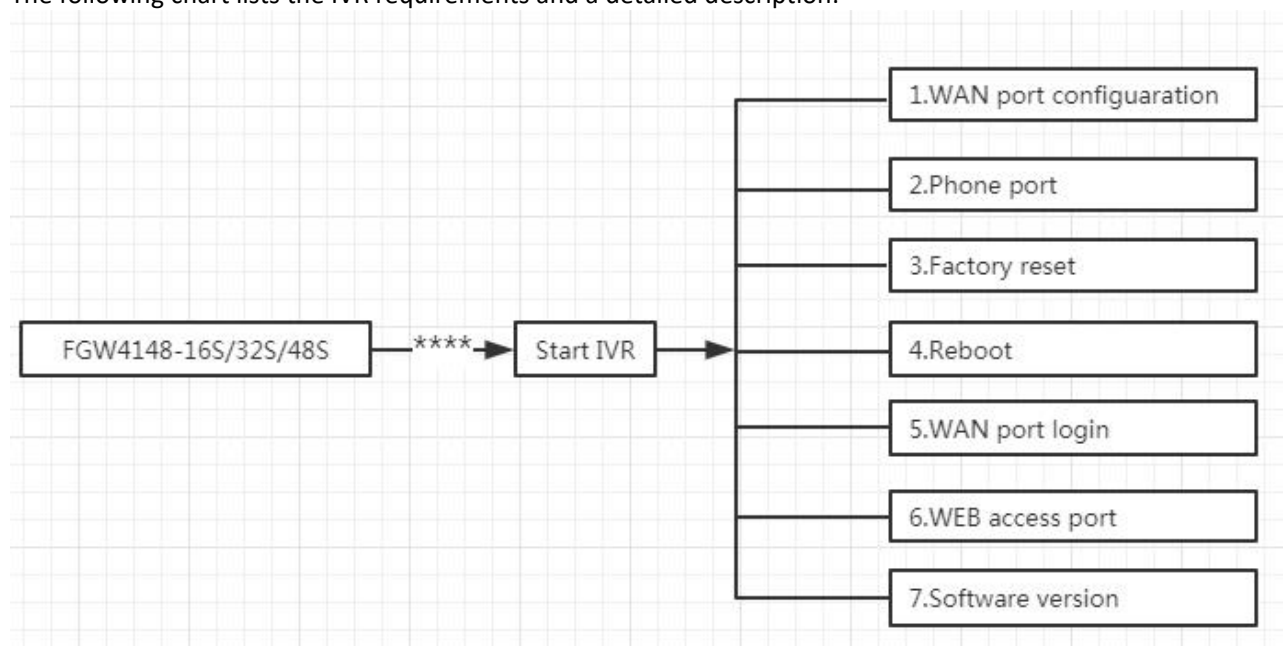

Table 8 IVR Menu Setting Options

Operation code	Menu
<p>1 (1) WAN Port Configuration</p>	<ol style="list-style-type: none"> 1. Pick up phone and press “****” to start IVR 2. Select "1", then the device will continue to broadcast to remind users to choose 1.WAN port connection type; 2.WAN port IP address; 3. WAN subnet mask; 4. adapter; 5. DNS 3. Choose “1” , and The router reports the current WAN port connection type2) 4. Prompt "Please enter password" , user needs to input password and press “#” key, if user wants to configuration WAN port connection type. The password in IVR is same as web management interface login, the user may use phone keypad to enter password directly For example: WEB login password is “admin” , so the password in IVR is “admin” . The user may “23646” to access and then configure the WAN connection port. The unit reports “Operation Successful” if the password is correct. 5. Prompt "Please enter password" , user needs to input password and press “#” key if user wants to configuration WAN port connection type. 6. Choose the new WAN port connection type (1) DHCP or (2) Static The unit reports “Operation Successful” if the changes are successful. The router returns to the prompt “please enter your option …” 7. To quit, enter “*”

<p>(2) WAN Port IP Address</p>	<ol style="list-style-type: none"> 1. Pick up phone and press “****” to start IVR 2. Choose “2”, and The router reports current WAN Port IP Address 3. Input the new WAN port IP address and press “#” key: 4. Use “*” to replace “.”, for example user can input 192*168*20*168 to set the new IP address 192.168.20.168 5. Press # key to indicate that you have finished 6. Report “operation successful” if user operation is ok. 7. To quit, enter “**” .
<p>(3) WAN Port Subnet Mask</p>	<ol style="list-style-type: none"> 1. Pick up phone and press “****” to start IVR 2. Choose “3”, and router reports current WAN port subnet mask 3. Input a new WAN port subnet mask and press # key: 4. Use “*” to replace “.”, user can input 255*255*255*0 to set the new WAN port subnet mask 255.255.255.0 5. Press “#” key to indicate that you have finished 6. Report “operation successful” if user operation is ok. 7. To quit, enter “**” .
<p>(4) adapter</p>	<ol style="list-style-type: none"> 1. Pick up phone and press “****” to start IVR 2. Choose “4”, and the router reports current adapter 3. Input the new adapter and press “#” key: 4. Use “*” to replace “.”, user can input 192*168*20*1 to set the new adapter 192.168.20.1. 5. Press “#” key to indicate that you have finished. 6. Report “operation successful” if user operation is ok. 7. To quit, press “**” .

<p>(5) DNS</p>	<ol style="list-style-type: none"> 1. Pick up phone and press “****” to start IVR 2. Choose “5”, and the router reports current DNS 3. Input the new DNS and press # key: 4. Use “*” to replace “.”, user can input 192*168*20*1 to set the new adapter 192.168.20.1. 5. Press “#” key to indicate that you have finished.
<p>2 phone port configuration</p>	<ol style="list-style-type: none"> 1. Pick up phone and press “****” to start IVR 2. Select "2", then the device will continue to broadcast prompts the user to select current phone number; 2. registration server address; 3. registration port; 4. call forwarding configuration, 5. DNS configuration ; 3. Continue pressing "1" and the unit will continue to broadcast the phone number of the current phone port. The device will then broadcast "1. Phone number ..." again.
<p>3 Factory Reset</p>	<ol style="list-style-type: none"> 1. Pick up phone and press “****” to start IVR 2. Choose “6”, and the router reports “Factory Reset” 3. Prompt "Please enter password", the method of inputting password is the same as operation 1. 4. If you want to quit, press “*” . 5. Prompt “operation successful” if password is right and then the router will be
<p>4 Reboot</p>	<ol style="list-style-type: none"> 1. Pick up phone and press “****” to start IVR 2. Choose “7”, and the router reports “Reboot” 3. Prompt "Please enter password", the method of inputting password is same as operation 1. 4. the router reboots if password is right and operation

5 WAN Port Login	<ol style="list-style-type: none">1. Pick up phone and press “****” to start IVR2. Choose “8”, and the router reports “WAN Port Login”3. Prompt "Please enter password", the method of inputting password is same as operation 1.4. If user wants to quit, press “*”.
6 WEB Access Port	<ol style="list-style-type: none">1. Pick up phone and press “****” to start IVR2. Choose “9”, and the router reports “ WEB Access Port”3. Prompt “Please enter password”, the method of inputting password is same as operation 1.4. Report “operation successful” if user operation is ok.
7 Firmware Version	<ol style="list-style-type: none">1. Pick up phone and press “****” to start IVR2. Choose “0” and the router reports the current Firmware version

**Note**

1. While using Voice menu, press * (star) to return to main menu.
2. If any changes made in the IP assignment mode, the router must be rebooted in order for the settings to take effect.
3. While entering an IP address or subnet mask, use "*" (star) to enter "." (Dot) and use "#" (hash) key to finish entering IP address or subnet mask:
4. For example, to enter the IP address 192.168.20.159 by keypad, press these keys:
192*168*20*159, use the #(hash) key to indicate that you have finished entering the IP address.
5. Use the # (hash) key to indicate that you have finish entering the IP address or subnet mask
6. While assigning an IP address in Static IP mode, setting the IP address, subnet mask and default adapter is required to complete the configuration. If in DHCP mode, please make sure that a DHCP server is available in your existing broadband connection to which WAN port of FGW4148-16S/32S/48S is connected.
7. The default LAN port IP address of FGW4148-16S/32S/48S is 192.168.11.1 and this address should not be assigned to the WAN port IP address of FGW4148-16S/32S/48S in the same network segment of LAN port.
8. The password can be entered using phone keypad, the mapping table between number and letters as follows:

To input: D, E, F, d, e, f -- press '3'

To input: G, H, I, g, h, i -- press '4'

To input: J, K, L, j, k, l -- press '5'

To input: M, N, O, m, n, o -- press '6'

To input: P, Q, R, S, p, q, r, s -- press '7'

To input: T, U, V, t, u, v -- press '8'

To input: W, X, Y, Z, w, x, y, z -- press '9'

To input all other characters in the administrator password-----press '0' .

Chapter 3 Basic Settings

This chapter covers:

- [WEB Page](#)
- [SIP Account Register](#)
- [Basic Function](#)

WEB Page

About Password

Our device supports two levels of management: administrators and users.

- (1) Administrator mode can browse and set all configuration parameters.
- (2) User mode can set all configuration parameters except SIP1/2 that some parameters can not be changed, such as server address and port.

- Default user with administrator mode: Username: admin, Password: admin
- Default user with user mode: Username: admin, Password: user

URL Format

FGW4148-16S/32S/48S has a built-in web server in response to HTTP get / post requests. Users can use a web browser, such as Microsoft's IE, to log in to the FGW4148-16S/32S/48S page and configure the FGW4148-16S/32S/48S

LAN port Login

- 1.Ensure your PC is connected to the router' s LAN port correctly.



Note

You may either set up your PC to get an IP dynamically from the router or set up the IP address of the PC to be the same subnet as the default IP address of router is 192.168.1.1. For detailed information, see Chapter 5: Troubleshooting Guide.

- 2.Open a web browser on your PC and input “http://192.168.1.1” .
- 3.The following window appears and prompts for username , password.

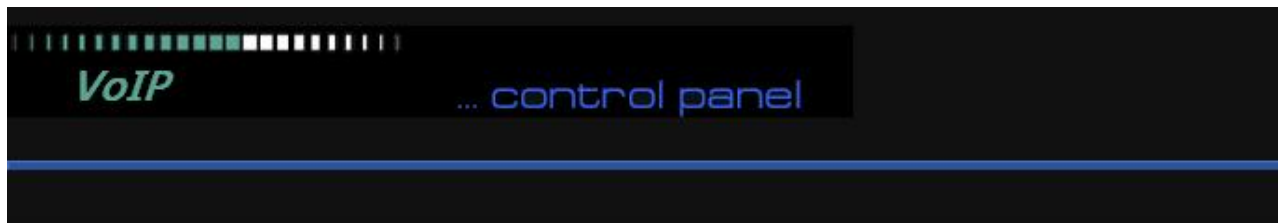

Username	<input type="text"/>	
Password	<input type="password"/>	<input type="button" value="Login"/>

- 4.For administrator mode operation, please type admin/admin on Username/Password and click Login to begin configuration.
- 5.For user mode operation, please type user/user on Username/Password and click Login to begin configuration.

**Note**

If you are unable to access the web configuration, please see Chapter 5: Troubleshooting Guide for more information.

6.The web management interface automatically logs out the user after 5 minutes of inactivity.

WAN port Login

- 1.Ensure your PC is connected to the router's WAN port correctly.
- 2.Obtain the IP addresses of WAN port using Voice prompt or by logging into the device web management interface via a LAN port and navigating to Network > WAN.
- 3.Open a web browser on your PC and input `http://<IP address of WAN port>`. The following login page will be opened to enter username and password.

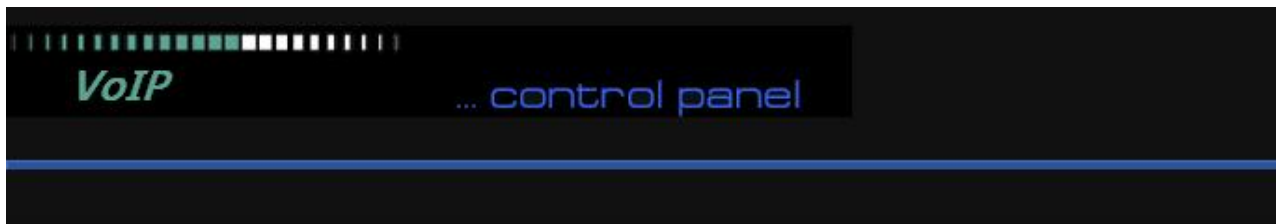

- 4.For administrator mode operation, type admin/admin on Username/Password and click Login to begin configuration.
- 5.For user mode operation, type user/user on Username/Password and click Login to begin configuration.

Note

If you fail to access to the web configuration, see Chapter 6: Troubleshooting Guide for more information.

6.The web management interface automatically logs out the user after 5 minutes of inactivity.

WEB Interface Introduction

Table 9 WEB Interface Introduction

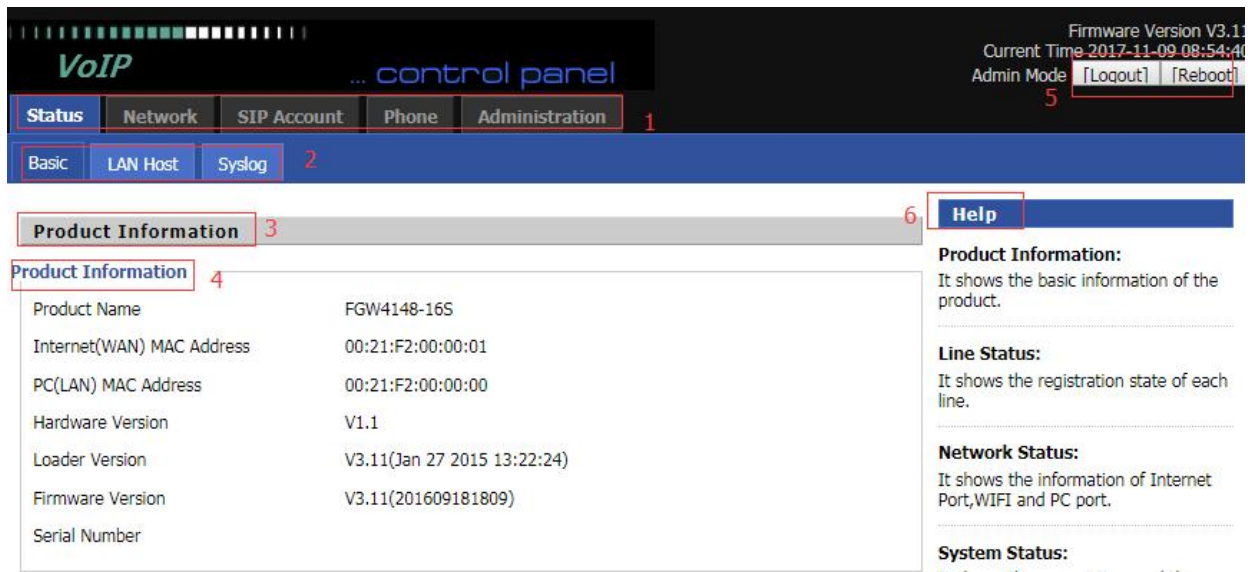

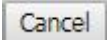
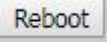
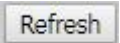
Serial number	Name	Description
Postition 1	navigation bar	Click navigation bar, many sub-navigation bar will appear in the place 2
Postition 2	sub-navigation bar	Click sub-navigation bar to enter to configuration page
Postition 3	configuration title	The configuration title
Postition 4	configuration bars	The configuration bars
Postition 5	main information	Display the firmware version, DSP version, Current Time, and user can change login level (mode) to return to login page by press blue Switch button.
Postition 6	Help	Display the main information for configuration; user can get help from it directly.
		After changing the parameters, you need to click this button to save. After you click Save, there is a need to restart the device.
		Click to cancel the change
		Click to restart
		Refresh current page

SIP Account Register

FGW4148-16S/32S/48S have 16/32/48 Lines to make SIP (Session Initiation Protocol) calls. Before registering, the device user should have SIP accounts configured by the system administrator or provider. See the section below for more information.

Register one by one

Table 10 Config SIP the Web Management Interface

Status	Network	SIP Account	Phone	Administration
Account	FXS Settings	SIP Settings	VoIP QoS	

Port: Batch Settings:

Basic

Basic Setup

Port Enable: Outgoing Call without Registration:

Proxy and Registration

Proxy Server	<input type="text" value="192.168.10.88"/>	Proxy Port	<input type="text" value="5060"/>
Outbound Server	<input type="text"/>	Outbound Port	<input type="text" value="5060"/>
Backup Outbound Server	<input type="text"/>	Backup Outbound Port	<input type="text" value="5060"/>

Subscriber Information

Display Name	<input type="text" value="601"/>	Phone Number	<input type="text" value="601"/>
Account	<input type="text" value="601"/>	Password	<input type="text" value="....."/>

Steps:

- Step 1. The account enable is set to "On" and the line can be used after opening.
- Step 2. The registration server fills in the IP address of the SIP server.
- Step 3. Display Name Fill in the content is the name of the number displayed on the LCD.
- Step 4. The registration account is filled with the account provided by the SIP server.
- Step 5. The name of the authentication is the SIP account provided by the SIP server.
- Step 6. The password is filled with the password provided by the SIP server registration account.
- Step 7. When you are finished, click the Save button at the bottom of the page to make the configuration take effect.
- Step 8. Check the registration of the corresponding line on the display / web status page.



Notes

Step 3-9 is to fill in the required content, other parameters fill in the required

Procedure

To view the SIP account status of device, open the **Status** web page and view the value of registration status.

Batch Registration

There are many FXS ports on the FGW4148-16S / 32S / 48S. One by one, configuration is very troublesome. Therefore, we support batch configuration of SIP accounts.

Taking FGW4148-16S as an example, batch configuration of SIP account steps:

1. Log in to the web page, switch to the **SIP Account - FXS Settings** page, check the "**Batch Settings**", and select

the need to set the batch FXS port.

2. Fill in the "Proxy Server", other parameters on request.

Status	Network	SIP Account	Phone	Administration
Account	FXS Settings	SIP Settings	VoIP QoS	

Start Port	FXS 1 ▼	Batch Settings <input checked="" type="checkbox"/>
End Port	FXS 16 ▼	

Basic

Basic Setup

Port Enable	Enable ▼	Outgoing Call without Registration	Disable ▼
-------------	----------	------------------------------------	-----------

Proxy and Registration

Proxy Server	192.168.10.88	Proxy Port	5060
Outbound Server		Outbound Port	5060
Backup Outbound Server		Backup Outbound Port	5060

3. Switch to **SIP Account - Account** page, fill in the batch configuration of FXS port account as required.

Status	Network	SIP Account	Phone	Administration
Account	FXS Settings	SIP Settings	VoIP QoS	

Account						
Port	Display Name	Phone Number	Account	Password	Enable	
FXS 1	601	601	601	<input checked="" type="checkbox"/>	Other settings
FXS 2	602	602	602	<input checked="" type="checkbox"/>	Other settings
FXS 3	603	603	603	<input checked="" type="checkbox"/>	Other settings
FXS 4					<input type="checkbox"/>	Other settings
FXS 5					<input type="checkbox"/>	Other settings
FXS 6					<input type="checkbox"/>	Other settings

4. Click "Save" button
5. Status page can view the registration status information.

Basic Function

Calling phone or extension numbers

To make a phone or extension number call:

- Both ATA and the other VoIP device (i.e., another ATA or other SIP products) must have public IP addresses, or
- Both ATA and the other VoIP device (i.e., another ATA or other SIP products) are on the same LAN using private or public IP addresses, or
- Both ATA and the other VoIP device (i.e., another ATA or other SIP products) can be connected through a router using a public or private IP addresses.

To make a call, first pick up the analog phone or turn on the speakerphone on the analog phone, input the IP address directly, end with #.

Direct IP calls

Direct IP calling allows two phones, that is, an ATA with an analog phone and another VoIP Device, to talk to each other without a SIP proxy. VoIP calls can be made between two phones if:

- Both ATA and the other VoIP device (i.e., another ATA or other SIP products) have public IP addresses, or
- Both ATA and the other VoIP device (i.e., another ATA or other SIP products) are on the same LAN

using private or public IP addresses, or

- Both ATA and the other VoIP device (i.e., another ATA or other SIP products) can be connected through a router using public or private IP addresses.

To make a direct IP call, first pick up the analog phone or turn on the speakerphone on the analog phone, Input the IP address directly, with the end “#” .

Call Hold

Method 1: While in conversation, pressing the “*77” to put the remote end on hold, then you will hear the dial tone and the remote party will hear hold tone at the same time.

Pressing the “*77” again to release the previously hold state and resume the bi-directional media.

Method 2: While in conversation, pressing the Flash key to put the remote end on hold, then you will hear the dial tone and the remote party will hear hold tone at the same time.

Pressing the Flash key again to release the previously hold state and resume the bi-directional media.

Call transfer

1. Blind Transfer

Assume that call party A and party B are in conversation. Party A wants to Blind Transfer B to C:

Method 1: Party A dials “*98” to get a dial tone, then dials party C’ s number, and then press immediately key # (or wait for 4 seconds) to dial out. A can hang up.

Method 2: Party A pressed the Flash key to get a dial tone, then dials party C’ s number, and then press immediately key # (or wait for 4 seconds) to dial out. A can hang up. C answers the call and talks to B.

When enabled R key and Flash as R key function, you can refer to the steps below to transfer:

Party A pressed the Flash key and number 4 key to get a dial tone, then dials party C’ s number, and then press immediately key # (or wait for 4 seconds) to dial out. A can hang up. C answers the call and talks to B.

2. Attended Transfer

Assume that call party A and B are in a conversation. A wants to Attend Transfer B to C:

Method 1: Party A dials “*77” to hold the party B, when hear the dial tone, A dials C’ s number, then party A and party C are in conversation.

Party A dials “*98” to transfer to C, then B and C now in conversation.

If the transfer is not completed successfully, then A and B are in conversation again.

Method 2: Party A presses the Flash key to hold the party B, when hear the dial tone, A dials C’ s

number, then party A and party C are in conversation. Party A hang up, then B and C now in conversation.

Conference

Assume that call party A and B are in a conversation. A wants to add C to the conference:

Method 1: Party A dials “*77” to hold the party B, when hear the dial tone, A dial C’ s number, then party A and party C are in conversation.

Party A dials “*88” to add C, then A and B, for conference.

Method 2: Party A pressed Flash key to hold the party B, when hear the dial tone, A dial C’ s number, then party A and party C are in conversation.

Party A pressed Flash key again, then A , B and C are in the same conversation.

Note: If this method is not working, please enable Bellcore Style 3-Way Conference option on the web interface.

The screenshot shows the 'Phone' administration interface with the 'Miscellaneous' settings page. The 'Bellcore Style 3-Way Conference' option is highlighted with a red box and is set to 'Enable'. Other settings include Loop Current (20), CID Service (Enable), Caller ID Method (Bellcore), Dial Time Out (IDT) (5), ICMP Ping (Disable), Ring Offset (0-50 V) (0), Info Content Type (broadsoft), Impedance Matching (US PBX,Korea,Taiwan(600)), CWCID Service (Disable), Call Immediately Key (#), Enable Escaped Char (Disable), On-hook Voltage (48), and Hook Flash Number Enable (Disable).

Setting	Value
Loop Current	20
CID Service	Enable
Caller ID Method	Bellcore
Dial Time Out (IDT)	5
ICMP Ping	Disable
Bellcore Style 3-Way Conference	Enable
Ring Offset (0-50 V)	0
Info Content Type	broadsoft
Impedance Matching	US PBX,Korea,Taiwan(600)
CWCID Service	Disable
Call Immediately Key	#
Enable Escaped Char	Disable
On-hook Voltage	48
Hook Flash Number Enable	Disable

Chapter 4 Web Interface

This chapter guides users to execute advanced (full) configuration through admin mode operation. This chapter covers:

- [Login](#)
- [Status](#)
- [Network](#)
- [SIP Account](#)
- [Phone](#)
- [Administration](#)

Login

Table 11 Login details



The screenshot shows a web interface for a VoIP control panel. At the top, there is a dark header with 'VoIP' in green text and '... control panel' in blue text. Below the header is a login form with a light gray background. The form contains two input fields: 'Username' with the text 'admin' and 'Password' with masked characters (dots). To the right of the password field is a 'Login' button.

Procedure

1. Connect the LAN port of the router to your PC an Ethernet cable
2. Open a web browser on your PC and type `http://192.168.1.1`.
3. Enter Username admin and Password admin.
4. Click Login

Status

This webpage shows the status information about the Product, Network, SIP Account Status, FXS Port Status, Network Status, Wireless Info and System Status

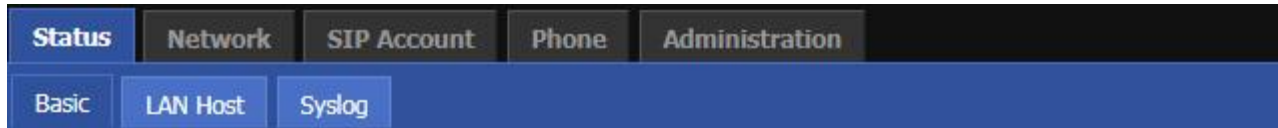

Product Information

Product Information

Product Name	FGW4148-16S
Internet(WAN) MAC Address	00:21:F2:00:00:01
PC(LAN) MAC Address	00:21:F2:00:00:00
Hardware Version	V1.1
Loader Version	V3.11(Jan 27 2015 13:22:24)
Firmware Version	V3.11(201609181809)
Serial Number	

Line Status

Line Status

Line 1 Status	Registered 601
Primary Server	192.168.10.88
Backup Server	192.168.10.88

Network

You can configure the WAN port, LAN port, DDNS, Multi WAN, DMZ, MAC Clone, Port Forward and other parameters in this section of the web management interface.

WAN

This page allows you to set WAN configuration with different modes. Use the Connection Type drop down list to choose one WAN mode and then the corresponding page will be displayed.

1.Static IP

This configuration may be utilized when a user receives a fixed public IP address or a public subnet,

namely multiple public IP addresses from the Internet providers. In most cases, a Cable service provider will offer a fixed public IP, while a DSL service provider will offer a public subnet. If you have a public subnet, you can assign an IP address to the WAN interface.

Table 12 Static IP

Status	Network	SIP Account	Phone	Administration		
WAN	LAN	VPN	DMZ	MAC Clone	Port Setting	Routing

INTERNET

WAN

Connect Name: 1_MANAGEMENT_VOICE_INTERNET_R_VID Delete Connect

Service: MANAGEMENT_VOICE_INTERNET

IP Protocol Version: IPv4

WAN IP Mode: Static

NAT Enable: Enable

VLAN Mode: Disable

VLAN ID: 1 (1-4094)

Static

IP Address: 192.168.10.247

Subnet Mask: 255.255.255.0

Default Gateway: 192.168.10.1

DNS Mode: Manual

Primary DNS: 192.168.10.1

Secondary DNS: 192.168.18.1

Port Bind

Port_1

Note : WAN connection can not be shared between the binding port , and finally bound port WAN connections bind operation will wash away before the other WAN connection to the port binding operation !

Field Name	Description
IP Address	The IP address of Internet port
Subnet Mask	The subnet mask of Internet port
Default adapter	The default adapter of Internet port
DNS Mode	<p>Select DNS mode, options are Auto and Manual:</p> <ol style="list-style-type: none"> When DNS mode is Auto, the device under LAN port will automatically obtain the preferred DNS and alternate DNS. When DNS mode is Manual, the user manually configures the preferred DNS and alternate DNS information

Primary DNS Address	The primary DNS of Internet port
Secondary DNS Address	The secondary DNS of Internet port

2.DHCP

The Router has a built-in DHCP server that assigns private IP address to each local client.

The DHCP feature allows to the router to obtain an IP address automatically from a DHCP server. In this case, it is not necessary to assign an IP address to the client manually.

Table 13 DHCP

Status	Network	SIP Account	Phone	Administration		
WAN	LAN	VPN	DMZ	MAC Clone	Port Setting	Routing

INTERNET	
WAN	
Connect Name	1_MANAGEMENT_VOICE_INTERNET_R_VID Delete Connect
Service	MANAGEMENT_VOICE_INTERNET
IP Protocol Version	IPv4
WAN IP Mode	DHCP
DHCP Server	
NAT Enable	Enable
VLAN Mode	Disable
VLAN ID	1 (1-4094)
DNS Mode	Manual
Primary DNS	
Secondary DNS	
DHCP	
DHCP Renew	Renew
DHCP Vendor(Option 60)	FLYINGVOICE-FGW4148-1
Port Bind	
<input checked="" type="checkbox"/> Port_1	
Note : WAN connection can not be shared between the binding port , and finally bound port WAN connections bind operation will wash away before the other WAN connection to the port binding operation !	
Field Name	Description

Select DNS mode, options are Auto and Manual:

DNS Mode

When DNS mode is Auto, the device under LAN port will automatically obtain the preferred DNS and alternate DNS.

When DNS mode is Manual, the user should manually configure the preferred

Primary DNS Address	Primary DNS of Internet port.
Secondary DNS Address	Secondary DNS of Internet port.
DHCP Renew	Refresh the DHCP IP address
DHCP Vendor (Option60)	Specify the DHCP Vendor field. Display the vendor and product name.

3.PPPoE

PPPoE stands for Point-to-Point Protocol over Ethernet. It relies on two widely accepted standards: PPP and Ethernet. It connects users through an Ethernet to the Internet with a common broadband medium, such as a single DSL line, wireless device or cable modem. All the users over the Ethernet can share a common connection.

PPPoE is used for most of DSL modem users. All local users can share one PPPoE connection for accessing the Internet. Your service provider will provide you information about user name, password, and authentication mode.

Table 14 PPPoE

Status	Network	SIP Account	Phone	Administration		
WAN	LAN	VPN	DMZ	MAC Clone	Port Setting	Routing

INTERNET	
WAN	
Connect Name	1_MANAGEMENT_VOICE_INTERNET_R_VID ▼ Delete Connect
Service	MANAGEMENT_VOICE_INTERNET ▼
IP Protocol Version	IPv4 ▼
WAN IP Mode	PPPoE ▼
NAT Enable	Enable ▼
VLAN Mode	Disable ▼
VLAN ID	1 (1-4094)
DNS Mode	Auto ▼
Primary DNS	<input type="text"/>
Secondary DNS	<input type="text"/>
PPPoE	
PPPoE Account	<input type="text"/>
PPPoE Password	••••••••
Confirm Password	••••••••
Service Name	<input type="text"/>
	Leave empty to autodetect
Operation Mode	Keep Alive ▼
Keep Alive Redial Period(0-3600s)	5

Field Name	Description
PPPoE Account	Enter a valid user name provided by the ISP
PPPoE Password	Enter a valid password provided by the ISP. The password can contain special characters and allowed special characters are \$, +, *, #, @ and ! For example, the password can be entered as #net123@IT!\$+*.
Confirm Password	Enter your PPPoE password again
Service Name	Enter a service name for PPPoE authentication. If it is left empty, the service name is auto detected.
Operation Mode	Select the mode of operation, options are Keep Alive, On Demand and Manual: When the mode is Keep Alive, the user sets the 'keep alive redial period' values range from 0 to 3600s, the default setting is 5 minutes; When the mode is On Demand, the user sets the 'on demand idle time' value in the range of 0-60 minutes, the default setting is 5 minutes; <div style="display: flex; justify-content: space-between; align-items: flex-start;"> <div style="text-align: left;"> <p>Operation Mode</p> <p>On Demand Idle Time(0-60m)</p> </div> <div style="text-align: right;"> <div style="border: 1px solid gray; padding: 2px; display: inline-block;">On Demand ▾</div> <div style="border: 1px solid gray; padding: 2px; display: inline-block; width: 40px; text-align: center;">5</div> </div> </div>
Keep Alive Redial Period	Set the interval to send Keep Alive messaging
PPPoE Account	Assign a valid user name provided by the ISP

4. Bridge Mode

Bridge Mode under Multi WAN is different with traditional bridge setting. Bridge mode employs no IP addressing and the device operates as a bridge between the WAN port and the LAN port. Route Connection has to be built to give IP address to local service on device.

Table 15 Bridge Mode

Status		Network		SIP Account		Phone		Administration	
WAN		LAN		VPN		DMZ		MAC Clone	
Port Setting		Routing							
INTERNET									
WAN									
Connect Name	1_MANAGEMENT_VOICE_INTERNET_R_VID ▼							Delete Connect	
Service	MANAGEMENT_VOICE_INTERNET ▼								
IP Protocol Version	IPv4 ▼								
WAN IP Mode	Bridge ▼								
Bridge Type	IP Bridge ▼								
DHCP Service Type	Pass Through ▼								
VLAN Mode	Disable ▼								
VLAN ID	1 (1-4094)								
Port Bind	<input checked="" type="checkbox"/> Port_1								
Note : WAN connection can not be shared between the binding port , and finally bound port WAN connections bind operation will wash away before the other WAN connection to the port binding operation !									
Field Name		Descriptio							
Bridge Type									
IP Bridge	Allow all Ethernet packets to pass. PC can connect to upper network directly.								
PPPoE Bridge	Only Allow PPPoE packets pass. PC needs PPPoE dial-up software.								
Hardware IP Bridge	Packets pass through hardware switch with wired speed. Does not support wireless port binding								
DHCP Service Type									
Pass Through	DHCP packets can be forwarded between WAN and LAN, DHCP server in adapter will not allocate IP to clients of LAN port.								
DHCP Snooping	When adapter forwards DHCP packets form LAN to WAN it will add option82 to DHCP packet, and it will remove option82 when forwarding DHCP packet from the WAN interface to the LAN interface. Local DHCP service will not allocate IP to clients of LAN port.								

Local Service adapter will not forward DHCP packets between LAN and WAN, it also blocks DHCP packets from the WAN port. Clients connected to the LAN port can get IP from DHCP server run in adapter.

VLAN Mode

Disable	The WAN interface is untagged. LAN is untagged.
Enable	The WAN interface is tagged. LAN is untagged.
Trunk	Only valid in bridge mode. All ports, including WAN and LAN, belong to this VLAN Id and all ports are tagged with this VLAN id. Tagged packets can pass through WAN and LAN.
VLAN ID	Set the VLAN ID.
802.1p	Set the priority of VLAN, Options are 0~7.



Note

Multiple WAN connections may be created with the same VLAN ID

LAN

LAN Port

NAT translates the packets from public IP address to local IP address to forward packets to the proper destination.

Table 16 LAN port

Status	Network	SIP Account	Phone	Administration		
WAN	LAN	VPN	DMZ	MAC Clone	Port Setting	Routing

PC Port(LAN)

PC Port(LAN)

Local IP Address

Local Subnet Mask

Local DHCP Server

DHCP Start Address

DHCP End Address

DNS Mode

Primary DNS

Secondary DNS

Client Lease Time(0-86400s)

DHCP Static Allotment

NO.	MAC	IP Address
1	<input type="text"/>	<input type="text"/>
2	<input type="text"/>	<input type="text"/>
3	<input type="text"/>	<input type="text"/>

DNS Proxy

Field Name	Description
IP Address	Enter the IP address of the router on the local area network. All the IP addresses of the computers which are in the router's LAN must be in the same network segment with this address, and the default adapter of the computers must be this IP address. (The default is 192.168.11.1).
Local Subnet Mask	Enter the subnet mask to determine the size of the network (default is 255.255.255.0/24).
Local DHCP Server	Enable/Disable Local DHCP Server.

DHCP Start Address	Enter a valid IP address as a starting IP address of the DHCP server, and if the router's LAN IP address is 192.168.11.1, starting IP address can be 192.168.11.2 or greater, but should be less than the ending IP address.
DHCP End Address	Enter a valid IP address as an end IP address of the DHCP server.
DNS Mode	Select DNS mode, options are Auto and Manual: When DNS mode is Auto, the device under LAN port will automatically obtains the preferred DNS and alternate DNS. When DNS mode is Manual, the user should manually configure the preferred DNS and alternate DNS.
Primary DNS	Enter the preferred DNS address.
Secondary DNS	Enter the secondary DNS address.
Client Lease Time	This option defines how long the address will be assigned to the computer within the network. In that period, the server does not assign the IP address to the other computer.
DNS Proxy	Enable or disable; If enabled, the device will forward the DNS request of LAN-side network to the WAN side network.

VPN

VPN is a technology that builds a private network on a public network. The connection between any two nodes of the VPN network does not have the end-to-end physical link required by the traditional private network, but rather the network platform provided by the public network service provider, and the user data is transmitted in the logical link. With VPN technology, you can establish private connections and transfer data between any two devices on the public network.

Table 17 PPTP

Status Network SIP Account Phone Administration

WAN LAN VPN DMZ MAC Clone Port Setting Routing

VPN Settings

Administration

VPN Enable	<input type="text" value="PPTP"/>
Initial Service IP	<input type="text"/>
User Name	<input type="text"/>
Password	<input type="password" value="....."/>
VPN As Default Route	<input type="text" value="Disable"/>
MPPE Stateful	<input type="text" value="Disable"/>
Require MPPE	<input type="text" value="Disable"/>

Parameters name	Description
VPN Enable	Whether to enable VPN. Select PPTP mode.
Initial Service IP	The IP address of the VPN server.
User Name	The user name required for authentication.
Password	The password required for authentication.
VPN As Default Route	Prohibited or open, the default is prohibited.
MPPE Stateful	Disable or enable MPPE Stateful.
Require MPPE	Disable or enable Require MPPE.

Table 18 L2TP

Status	Network	SIP Account	Phone	Administration		
WAN	LAN	VPN	DMZ	MAC Clone	Port Setting	Routing

VPN Settings	
Administration	
VPN Enable	L2TP ▼
Initial Service IP	<input type="text"/>
User Name	<input type="text"/>
Password	••••••••
L2TP Tunnel Name	<input type="text"/>
L2TP Tunnel Password	••••••••
VPN As Default Route	Disable ▼

Parameters name	Description
VPN Enable	Whether to enable VPN. Select PPTP mode.
Initial Service IP	The IP address of the VPN server.
User Name	The user name required for authentication.
Password	The password required for authentication.
L2TP Tunnel Name	L2TP Tunnel Name
L2TP Tunnel Password	L2TP Tunnel Password
VPN As Default Route	Prohibited or open, the default is prohibited.

Table 19 OpenVPN

Status	Network	SIP Account	Phone	Administration		
WAN	LAN	VPN	DMZ	MAC Clone	Port Setting	Routing

VPN Settings	
Administration	
VPN Enable	OpenVPN ▼
OpenVPN TLS Auth	Disable ▼
VPN As Default Route	Disable ▼

Parameters name	Description
VPN Enable	Whether to enable VPN. Select OpenVPN mode.
OpenVPN TLS Auth	Whether OpenVPN TLS authentication is enabled
VPN As Default Route	Prohibited or open, the default is prohibited.

DMZ

Table 20 DMZ

Status	Network	SIP Account	Phone	Administration		
WAN	LAN	VPN	DMZ	MAC Clone	Port Setting	Routing

Demilitarized Zone (DMZ)	
DMZ Setting	
DMZ Enable	Enable ▼
DMZ Host IP Address	<input type="text"/>

Field Name	Description
DMZ Enable	Enable/Disable DMZ.
DMZ Host IP Address	Enter the private IP address of the DMZ host.

MAC Clone

Some ISPs will require you to register your MAC address. If you do not wish to re-register your MAC address, you can have the router clone the MAC address that is registered with your ISP. To use the Clone Address button, the computer viewing the Web-base utility screen will have the MAC address automatically entered in the Clone WAN MAC field.

Table 21 MAC Clone

Status	Network	SIP Account	Phone	Administration		
WAN	LAN	VPN	DMZ	MAC Clone	Port Setting	Routing

MAC Address Clone

MAC Address Clone

MAC Address Clone

MAC Address

Config steps:

1. Enabling MAC address cloning
2. Press the button gets PC's MAC address
3. Press the button to save your changes if users don't want to use MAC clone, press the button to cancel the changes
4. Press the button to make the changes effective.

Port Setting

Table 22 Port setting

Status	Network	SIP Account	Phone	Administration		
WAN	LAN	VPN	DMZ	MAC Clone	Port Setting	Routing

Port Setting

Port Setting

WANPort Speed Nego

LAN1Port Speed Nego

Field Name	Description
WAN Port speed Nego	Auto-negotiation, options are Auto, 100M full, 100M half-duplex, 10M half and full.

LAN Port Speed Nego	Auto-negotiation, options are Auto, 100M full, 100M half, 10M half and 10M full.
---------------------	--

Routing

Table 23 Routing

Status	Network	SIP Account	Phone	Administration		
WAN	LAN	VPN	DMZ	MAC Clone	Port Setting	Routing

Static Routing Settings

Add a routing rule

Destination	<input type="text"/>
Host/Net	Host ▾
Gateway	<input type="text"/>
Interface	LAN ▾
Comment	<input type="text"/>
<input type="button" value="Apply"/> <input type="button" value="Reset"/>	

Current Routing table in the system

No.	Destination	Mask	Gateway	Flags	Metric	Interface	Comment
<input type="button" value="Delete Selected"/> <input type="button" value="Reset"/>							

Field Name	Description
Destination	Destination address
Host/Net	Both Host and Net selection
adapter	adapter IP address
Interface	LAN/WAN/Custom three options, and add the corresponding address
Comment	Comment

SIP Account

Account

You can set each FXS's display name, phone number, account and password in this page, the corresponding FXS will be enable after checked enable .then save your settings. Click "Other settings" go to the "FXS Settings" web page. SIP Settings.

Status	Network	SIP Account	Phone	Administration
Account	FXS Settings	SIP Settings	VoIP QoS	

Account						
Port	Display Name	Phone Number	Account	Password	Enable	
FXS 1	601	601	601	<input checked="" type="checkbox"/>	Other settings
FXS 2	602	602	602	<input type="checkbox"/>	Other settings
FXS 3					<input type="checkbox"/>	Other settings
FXS 4					<input type="checkbox"/>	Other settings
FXS 5					<input type="checkbox"/>	Other settings
FXS 6					<input type="checkbox"/>	Other settings
FXS 7					<input type="checkbox"/>	Other settings
FXS 8					<input type="checkbox"/>	Other settings
FXS 9					<input type="checkbox"/>	Other settings
FXS 10					<input type="checkbox"/>	Other settings
FXS 11					<input type="checkbox"/>	Other settings
FXS 12					<input type="checkbox"/>	Other settings

FXS Settings

Basic

Set the basic information provided by your VOIP Service Provider, such as Phone Number, Account, password, SIP Proxy and others.

Table 24 Line

Status	Network	SIP Account	Phone	Administration
Account	FXS Settings	SIP Settings	VoIP QoS	
Port	FXS 1 ▼	Batch Settings	<input type="checkbox"/>	
Basic				
Basic Setup				
Port Enable	Enable ▼	Outgoing Call without Registration	Disable ▼	
Proxy and Registration				
Proxy Server	192.168.10.88	Proxy Port	5060	
Outbound Server		Outbound Port	5060	
Backup Outbound Server		Backup Outbound Port	5060	
Subscriber Information				
Display Name	601	Phone Number	601	
Account	601	Password	

Field Name	Description
Line Enable	Enable/Disable the line.
Outgoing Call without Registration	Enable/Disable Outgoing Call without Registration If enabled, SIP-1 will not send register request to SIP server; but in Status/ SIP Account Status webpage, Status is Registered; lines 1 can dial out, but the external line number cannot dialed line1.
Proxy Server	The IP address or the domain of SIP Server
Outbound Server	The IP address or the domain of Outbound Server
Backup Outbound Server	The IP address or the domain of Backup Outbound Server
Proxy port	SIP Service port, default is 5060
Outbound Port	Outbound Proxy' s Service port, default is 5060
Backup Outbound Port	Backup Outbound Proxy' s Service port, default is 5060
Display Name	The number will be displayed on LCD
Phone Number	Enter telephone number provided by SIP Proxy
Account	Enter SIP account provided by SIP Proxy

Password	Enter SIP password provided by SIP Proxy
----------	--

Audio Configuration

Table 25 Audio configuration

Audio Configuration			
Codec Setup			
Audio Codec Type 1	G.711U ▼	Audio Codec Type 2	G.711A ▼
Audio Codec Type 3	G.729 ▼	Audio Codec Type 4	G.722 ▼
Audio Codec Type 5	G.723 ▼	Audio Codec Type 6	G726-32 ▼
Audio Codec Type 7	iLBC ▼		
G.723 Coding Speed	5.3k bps ▼	Packet Cycle (ms)	20 ▼
Silence Supp	Disable ▼	Echo Cancel	Enable ▼
Auto Gain Control	Disable ▼	Use First Matching Vocoder in 2000K SDP	Disable ▼
Codec Priority	Remote ▼	Packet Cycle Follows Remote SDP	Disable ▼
FAX Configuration			
FAX Mode	T.30 ▼	Bypass Attribute Value	fax/modem ▼
Enable T.38 CNG Detect	Disable ▼	Enable T.38 CED Detect	Enable ▼
Enable gpmdd attribute	Disable ▼	T.38 Redundancy	Disable ▼
Max Fax Rate	14400 ▼		

Field Name	Description
Audio Codec Type1	Choose the audio codec type from G.711U, G.711A, G.722, G.729, G.723
Audio Codec Type2	Choose the audio codec type from G.711U, G.711A, G.722, G.729, G.723
Audio Codec Type3	Choose the audio codec type from G.711U, G.711A, G.722, G.729, G.723
Audio Codec Type4	Choose the audio codec type from G.711U, G.711A, G.722, G.729, G.723
Audio Codec Type5	Choose the audio codec type from G.711U, G.711A, G.722, G.729, G.723
G.723 Coding Speed	Choose the speed of G.723 from 5.3kbps and 6.3kbps
Packet Cycle	The RTP packet cycle time, default is 20ms
Silence Supp	Enable/Disable silence support
Echo Cancel	Enable/Disable echo cancel. By default, it is enabled
Auto Gain Control	Enable/Disable auto gain
T.38 Enable	Enable/Disable T.38
T.38 Redundancy	Enable/Disable T.38 Redundancy
T.38 CNG Detect Enable	Enable/Disable T.38 CNG Detect
gpmdd attribute Enable	Enable/Disable gpmdd attribute

Supplementary Service Subscription

Table 26 Supplementary service

Supplementary Service Subscription	
Supplementary Services	
Call Waiting	Enable ▾
MWI Enable	Enable ▾
MWI Subscribe Enable	Disable ▾
DND	Disable ▾
Hot Line	<input type="text"/>
Voice Mailbox Numbers	<input type="text"/>
VMWI Serv	Enable ▾
Speed Dial	
Speed Dial 2	<input type="text"/>
Speed Dial 4	<input type="text"/>
Speed Dial 6	<input type="text"/>
Speed Dial 8	<input type="text"/>
Speed Dial 3	<input type="text"/>
Speed Dial 5	<input type="text"/>
Speed Dial 7	<input type="text"/>
Speed Dial 9	<input type="text"/>
Field Name	Description
Call Waiting	Enable/Disable Call Waiting
Hot Line	Fill in the hotline number,Pickup handset or press hands-free or headset button, the device will dial out the hotline number automatically
MWI Enable	Enable/Disable MWI (message waiting indicate). If the user needs to user voice mail, please enable this feature
MWI Subscribe Enable	Enable/Disable MWI Subscribe
Voice Mailbox Numbers	Fill in the voice mailbox phone number, Asterisk platform, for example, its default voice mail is *97
DND	Enable/Disable DND (do not disturb)
Speed Dial	Enter the speed dial phone numbers. Dial *74 to active speed dial function Then press the speed dial numbers, for example, press 2, phone dials 075526099365 directly

Advanced

Table 27 Advanced

Advanced			
SIP Advanced Setup			
Domain Name Type	Enable ▾	Carry Port Information	Disable ▾
Signal Port	53378	DTMF Type	Inband ▾
RFC2833 Payload(>=96)	101	Register Refresh Interval(sec)	3600
Caller ID Header	FROM ▾	Remove Last Reg	Enable ▾
Session Refresh Time(sec)	0	Refresher	UAC ▾
SIP 100REL Enable	Disable ▾	SIP OPTIONS Enable	Disable ▾
Initial Reg With Authorization	Disable ▾	Reply 182 On Call Waiting	Disable ▾
Primary Server Detect Interval	0	Max Detect Fail Count	3
NAT Keep-alive Interval(10-60s)	15	Anonymous Call	Disable ▾
Anonymous Call Block	Disable ▾	Proxy DNS Type	A Type ▾
Use OB Proxy In Dialog	Disable ▾	Complete Register	Disable ▾
Reg Subscribe Enable	Disable ▾	Reg Subscribe Interval(sec)	0
Dial Prefix		User Type	Phone ▾
Hold Method	ReINVITE ▾	Request-URI User Check	Enable ▾
Only Recv Request From Server	Disable ▾	Server Address	
SIP Received Detection	Disable ▾	VPN	Disable ▾
SIP Encrypt Type	Disable ▾	RTP Encrypt Type	Disable ▾
Country Code		Remove Country Code	Disable ▾
Tel URL	Disable ▾	Use Random SIP Port	Enable ▾
Min Random SIP Port	50000	Max Random SIP Port	60000
Prefer Primary SIP Server	Disable ▾		
RTP Advanced Setup			
RTP Port Min	0 (0 means auto select)	RTP Port Max	50000

Parameter name	Description
Domain Name Type	Whether to enable domain name recognition in SIP URIs
Carry Port Information	Whether to carry the SIP URI port information
Signal Port	The local port number of the SIP protocol
DTMF Type	Select the second way of dialing, optional items are In-band, RFC2833 and SIP Info.
RFC2833 Payload(>=96)	The user can use the default settings
Register Refresh Interval(sec)	The time interval between two normal registration messages. The user can use the default settings.

Caller ID Header	When enabled, an unregistered message will be sent before the registration is disabled, and no unregistered messages will be sent before registration; should be set according to the different server requirements
Remove Last Reg	Whether to remove the last registration message
Session Refresh Time(sec)	The interval between two sessions, the user can use the default settings
Refresher	Select Refresh from UAC and UAS
SIP 100REL Enable	If this option is enabled, the IP phone will send SIP-OPTION to the server instead of sending Hello messages on a regular basis. The interval for sending is the parameter set for the "NAT Hold Interval" parameter.
SIP OPTIONS Enable	Whether to open the SIP OPTION function
Initial Reg With Authorization	Whether to carry the certification information when registering
Reply 182 On Call Waiting	Whether or not to send 182 when the call is waiting
NAT Keep-alive Interval(10-60s)	The time interval for sending empty packets
Anonymous Call	Whether anonymous calls are enabled
Anonymous Call Block	Whether to enable anonymous call blocking
Proxy DNS Type	Set the DNS server type, the optional items are Type A, DNS SRV, and Auto
Use OB Proxy In Dialog	Whether the OB agent is used in the conversation
Complete Register	Whether to enable full registration
Reg Subscribe Enable	When enabled, the subscription message is sent after the registration message; the subscription message is not sent when disabled
Reg Subscribe Interval(sec)	Disable or enable Reg Subscribe Interval
Dial Prefix	Dial before prefix
User Type	Whether the end user is IP or Phone
Hold Method	Call hold is REINVITE or INFO
Request-URI User Check	Whether to allow the user to check
Only Recv Request From Server	If enabled, will only accept requests from the server, do not accept other requests
Server Address	SIP server address
SIP Received Detection	Whether to allow SIP receive detection
VPN	Whether to enable VPN
SIP Encrypt Type	Whether to allow SIP message encryption
RTP Encrypt Type	Whether to allow RTP message encryption
Country Code	Country code

Remove Country Code	Whether to allow the removal of national codes
Tel URL	Whether to open the Tel URL
Use Random SIP Port	Whether to use the minimum random port
Min Random SIP Port	SIP minimum random port
Max Random SIP Port	SIP maximum random port
Prefer Primary SIP Server	Whether to enable the preferred primary server
Hold SDP Attribute Inactive	Whether to enable the call to keep the inactive attribute
RTP Port Min	RTP minimum port
RTP Port Max	RTP's maximum port

SIP Settings

Table 28 SIP Settings

Status	Network	SIP Account	Phone	Administration
Account	FXS Settings	SIP Settings	VoIP QoS	

SIP Parameters

SIP Parameters

SIP T1	<input type="text" value="500"/> ms	Max Forward	<input type="text" value="70"/>
SIP User Agent Name	<input type="text"/>	Max Auth	<input type="text" value="2"/>
Reg Retry Intvl	<input type="text" value="30"/> sec	Reg Retry Long Intvl	<input type="text" value="1200"/> sec
Mark All AVT Packets	<input type="button" value="Enable"/> ▾	RFC 2543 Call Hold	<input type="button" value="Enable"/> ▾
SRTP	<input type="button" value="Disable"/> ▾	SRTP Prefer Encryption	<input type="button" value="AES_CM"/> ▾
Service Type	<input type="button" value="Common"/> ▾	DNS Refresh Timer	<input type="text" value="0"/> sec

Response Status Code Handling

Retry Reg RSC	<input type="text"/>
---------------	----------------------

NAT Traversal

NAT Traversal

NAT Traversal	<input type="button" value="Disable"/> ▾	STUN Server Address	<input type="text"/>
NAT Refresh Interval(sec)	<input type="text" value="60"/>	STUN Server Port	<input type="text" value="3478"/>

Parameters name	Description
SIP Parameters	
SIP T1	The default value is 500
SIP User Agent Name	Enter the SIP User Agent header field
Max Forward	Modify the maximum hop value, the default is 70

Max Auth	Change the number of authentication failures, the default value is 2
Reg Retry Intvl	Registration failed again registration interval, default is 30
Reg Retry Long Intvl	Registration failed Register again for the long interval Default 1200
Mark All AVT Packets	The default enable is on
RFC 2543 Call Hold	The default enable is on
SRTP	The default is disabled
SRTP Prefer Encryption	Support for AES_CM and ARIA_CM
Service Type	Default general
DNS Refresh Timer	Modify the DNS refresh time, the default value of 0
Transport	The transmission type defaults to UDP
Response Status Code Handling	
Retry Reg RSC	You can fill in Retry Reg RSC here
NAT Traversal	
NAT Traversal	Whether to enable NAT mode, or select STUN to penetrate
STUN Server Address	STUN server IP address
NAT Refresh Interval(sec)	Refresh interval
STUN Server Port	STUN port, the default is 3478

VoIP QoS

Table 29 VoIP QoS

Status	Network	SIP Account	Phone	Administration
Account	FXS Settings	SIP Settings	VoIP QoS	
QoS Settings				
Layer 3 QoS				
SIP QoS(0-63)		46		
RTP QoS(0-63)		46		
Parameters name	Description			
SIP QoS(0-63)	Defaults to 46,you can set a range of values is 0~63			
RTP QoS(0-63)	Defaults to 46,you can set a range of values is 0~63			

Configuration can be based on the scene environment to modify the parameters

Phone

Preferences

Preferences

Table 30 Preferences

Field Name	Description
Handset Input Gain	Adjust the handset input gain from 0 to 7.
Handset Volume	Adjust the output gain from 0 to 7.

Regional

Table 31 Regional

Tone Type	USA ▼		
Dial Tone	<input type="text"/>		
Busy Tone	<input type="text"/>		
Off Hook Warning Tone	<input type="text"/>		
Ring Back Tone	<input type="text"/>		
Call Waiting Tone	<input type="text"/>		
Min Jitter Delay(0-600ms)	<input type="text" value="20"/>	Max Jitter Delay(20-1000ms)	<input type="text" value="160"/>
Ring Time(10-300sec)	<input type="text" value="60"/>		
Ring Waveform	Sinusoid ▼	Ring Voltage(40-63 Vrms)	<input type="text" value="45"/>
Ring Frequency(15-30Hz)	<input type="text" value="25"/>	VMWI Ring Splash Len(0.1-10sec)	<input type="text" value="0.5"/>
Flash Time Max(0.2-1sec)	<input type="text" value="0.9"/>	Flash Time Min(0.1-0.5sec)	<input type="text" value="0.1"/>

Field Name	Description
Tone Type	Choose tone type form China, US, Hong Kong and so on.
Dial Tone	Dial Tone
Busy Tone	Busy Tone
Off Hook Warning	Off Hook warning tone
Ring Back Tone	Ring back tone
Call Waiting Tone	Call waiting tone
Min Jitter Delay	The Min value of home adapter' s jitter delay, home adapter is an adaptive jitter mechanism.
Max Jitter Delay	The Max value of home adapter' s jitter delay, home adapter is an adaptive jitter mechanism.
Ringling Time	How long CnPilot Home R190/R200x will ring when there is an incoming call.
Ring Waveform	Select regional ring waveform, options are Sinusoid and Trapezoid, the default Sinusoid.
Ring Voltage	Set ringing voltage, the default value is 70
Ring Frequency	Set ring frequency, the default value is 25
VMWI Ring Splash Len(sec)	Set the VMWI ring splash length, default is 0.5s.
Flash Time Max(sec)	Set the Max value of the device' s flash time, the default value is 0.9
Flash Time Min(sec)	Set the Min value of the device' s flash time, the default value is 0.1

Features and Call Forward

Table 32 Features and call forward

Features			
All Forward	<input type="text" value="Disable"/>	Busy Forward	<input type="text" value="Disable"/>
No Answer Forward	<input type="text" value="Disable"/>	Transfer On Hook	<input type="text" value="Enable"/>

Call Forward			
All Forward	<input type="text"/>	Busy Forward	<input type="text"/>
No Answer Forward	<input type="text"/>	No Answer Timeout	<input type="text" value="20"/>

Feature Code			
Hold Key Code	<input type="text" value="*77"/>	Conference Key Code	<input type="text" value="*88"/>
Transfer Key Code	<input type="text" value="*98"/>	IVR Key Code	<input type="text" value="****"/>
R Key Enable	<input type="text" value="Disable"/>	R Key Cancel Code	<input type="text" value="R1"/>
R Key Hold Code	<input type="text" value="R2"/>	R Key Transfer Code	<input type="text" value="R4"/>
R Key Conference Code	<input type="text" value="R3"/>	Speed Dial Code	<input type="text" value="*74"/>

Field Name		Description
Features	All Forward	Enable/Disable forward all calls
	Busy Forward	Enable/Disable busy forward.
	No Answer Forward	Enable/Disable no answer forward.
Call Forward	All Forward	Set the target phone number for all forward. The device will forward all calls to the phone number immediately when there is an incoming call.
	Busy Forward	The phone number which the calls will be forwarded to when line is busy.
	No Answer Forward	The phone number which the call will be forwarded to when there's no answer.
	No Answer Timeout	The seconds to delay forwarding calls, if there is no answer at your phone.
Feature Code	Hold key code	Call hold signatures, default is *77.
	Conference key code	Signature of the tripartite session, default is *88.
	Transfer key code	Call forwarding signatures, default is *98.
	IVR key code	Signatures of the voice menu, default is ****.

R key enable	Enable/Disable R key way call features.
R key cancel code	Set the R key cancel code, option are ranged from R1 to R9, default value is R1.
R key hold code	Set the R key hold code, options are ranged from R1 to R9, default value is R2.
R key transfer code	Set the R key transfer code, options are ranged from R1 to R9, default value is R4.
R key conference code	Set the R key conference code, options are ranged from R1 to R9, default value is R3.
R Key Reject 2nd Call Code	Set the R key Reject 2nd Call code, options are ranged from R1 to R9, default value is R0.
Speed Dial Code	Speed dial code, default is *74.

Miscellaneous

Table 33 Miscellaneous

Miscellaneous

Loop Current	<input type="text" value="26"/>	Impedance Maching	<input type="text" value="US PBX,Korea,Taiwan(600)"/>
CID Service	<input type="text" value="Enable"/>	CWCID Service	<input type="text" value="Disable"/>
Caller ID Method	<input type="text" value="Bellcore"/>	Polarity Reversal	<input type="text" value="Disable"/>
Dial Time Out(IDT)	<input type="text" value="5"/>	Call Immediately Key	<input type="text" value="#"/>
ICMP Ping	<input type="text" value="Disable"/>	Escaped char enable	<input type="text" value="Disable"/>
Bellcore Style 3-Way Conference	<input type="text" value="Disable"/>	On-Hook Voltage	<input type="text" value="48"/>

Field Name	Description
Codec Loop Current	Set off-hook loop current, default is 26
Impedance Maching	Set impedance matching, default is US PBX,Korea,Taiwan(600).
CID service	Enable/Disable displaying caller ID; If enable, caller ID is displayed when there is an incoming call or it won’ t be displayed. Default is enable.
CWCID Service	Enable/Disable CWCID. If enable, the device will display the waiting call’ s caller ID, or it won’ t display. Default is disable.
Dial Time Out	How long device will sound dial out tone when device dials a number.
Call Immediately Key	Choose call immediately key form * or #.

ICMP Ping	Enable/Disable ICMP Ping. If enable this option, home adapter will ping the SIP Server every interval time, otherwise, It will send “hello” empty packet to the SIP Server.
Escaped char enable	Open special character translation function; if enable, when you press the # key, it will be translated to 23%, when disable, it is just #

Dial Rule

Table 34 Dial Plan

Status	Network	SIP Account	Phone	Administration
Preferences	Dial Plan	Call Log		
Dial Plan				
General				
Dial Plan Enable	Disable ▼			
Unmatched Policy	Accept ▼			
Dial Plan config				
				
Field Name	Description			
Dial Plan Enable	Enable/Disable dial plan.			
Unmatched Policy				

Dial Plan Syntactic

Table 35 Dial Plan Syntactic

No.	String	Description
1	0 1 2 3 4 5 6 7 8 9 * #	Allowed characters
2	x	Lowercase letter x stands for one legal character

3	[sequence]	<p>To match one character form sequence. For example: [0-9]: match one digit form 0 to 9 [23-5*]: match one character from 2 or 3 or 4 or 5 or *</p> <p style="text-align: center;">$x^0 \ x^1 \ x^2 \ x^3 \ x^n$</p>
4	x.	<p>Match to , , , For example: “01.” :can match ” 0” , “01” , “011” , ” 0111” , , ” 01111...”</p>
5	<dialed:substituted>	<p>Replace dialed with substituted. For example: <8:1650>123456: input is “85551212” , output is “16505551212”</p>
6	x,y	<p>Make outside dial tone after dialing “x” , stop until dialing character “y” For example: “9,1xxxxxxxx” :the device reports dial tone after inputting “9” , stops tone until inputting “1”</p>
7	T	<p>Set the delayed time. For example: “<9:111>T2” : The device will dial out the matched number “111” after 2 seconds.</p>

Call Log

To view the call log information such as redial list , answered call and missed call

Table 36 Call log

Redial Calls				
Redial List				
Index	NUMBER	Start Time	Duration	<input type="checkbox"/>
1	123	10/28 10:30	00:00:07	<input type="checkbox"/>
2	010123	10/28 12:02	00:00:01	<input type="checkbox"/>
3	010123	10/28 16:16	00:00:00	<input type="checkbox"/>
4	010123	10/28 16:16	00:00:00	<input type="checkbox"/>
5	123	10/28 16:20	00:00:13	<input type="checkbox"/>
6	123	10/28 16:21	00:00:34	<input type="checkbox"/>
7	123	10/29 10:50	00:00:10	<input type="checkbox"/>
8	123	10/29 14:36	00:00:01	<input type="checkbox"/>
9	123	10/29 15:05	00:00:23	<input type="checkbox"/>
10	123	10/29 15:06	00:00:05	<input type="checkbox"/>
...	<input type="checkbox"/>

Answered Calls

Answered Calls				
Index	NUMBER	Start Time	Duration	
1	22222	10/21 09:56	00:00:40	<input type="checkbox"/>
2	110	10/21 18:14	00:00:03	<input type="checkbox"/>
3	110	10/21 18:15	00:00:07	<input type="checkbox"/>
4	sipp	10/23 13:40	00:00:06	<input type="checkbox"/>
5	sipp	10/24 18:05	00:00:05	<input type="checkbox"/>
6	sipp	10/24 18:05	00:00:05	<input type="checkbox"/>
7	sipp	10/25 15:38	00:00:03	<input type="checkbox"/>
8	sipp	10/25 15:42	00:00:06	<input type="checkbox"/>
9	sipp	10/25 15:55	00:00:10	<input type="checkbox"/>
10	sipp	10/25 16:03	00:00:02	<input type="checkbox"/>

Missed Calls

Missed Calls				
Index	NUMBER	Start Time	Duration	
1	110	10/21 09:50	00:00:03	<input type="checkbox"/>
2	555	10/22 12:04	00:00:03	<input type="checkbox"/>

Administration

The user can manage the device in these webpages; you can configure the Time/Date, password, web access, system log and associated configuration TR069.

Management

Save config file

Table 37 Save Config File

Save Config File

Config File Upload & Download

Local File 选择文件 未选择任何文件

Upload Download

Field Name	Description
Config file upload and download	Upload: click on browse, select file in the local, press the upload button to begin uploading files

Download: click to download, and then select contains the path to download the configuration file

Administrator settings

Table 38 Administrator settings

Administrator Settings	
Password Reset	
User Type	Admin User ▼
New User Name	admin
New Password	<input type="text"/> (The maximum length is 25)
Confirm Password	<input type="text"/>
Language	
Language	English ▼
VPN Access	
Management Using VPN	Disable ▼
Web Access	
Remote Web Login	Enable ▼
Local Web Port	80
Web Port	80
Web SSL Port	443
Web Idle Timeout(0 - 60min)	5
Allowed Remote IP(IP1;IP2;...)	0.0.0.0
Telnet Access	
Remote Telnet	Enable ▼
Telnet Port	23
Allowed Remote IP(IP1;IP2;...)	0.0.0.0
HostName	FWR8102

Field Name	Description
User type	Choose the user type from admin user and normal user and basic user
New User Name	You can modify the user name, set up a new user name
New Password	Input the new password
Confirm Password	Input the new password again
Language	Select the language for the web, the device support Chinese, English, and Spanish and so on
Remote Web Login	Enable/Disable remote Web login
Web Port	Set the port value which is used to login from Internet port and PC port, default is 80

Web Idle timeout	Set the Web Idle timeout time. The webpage can be logged out after Web Idle Timeout without any operation
Allowed Remote IP(IP1,IP2,...)	Set the IP from which a user can login the device remotely
Telnet Port	Set the port value which is used to telnet to the device

NTP settings

Table 39 NTP settings

Time/Date Setting

NTP Settings

NTP Enable Enable ▼

Option 42 Disable ▼

Current Time 2016 - 01 - 19 . 05 : 55 : 06

Sync with host Sync with host

NTP Settings (GMT-06:00) Central Time ▼

Primary NTP Server pool.ntp.org

Secondary NTP Server

NTP synchronization(1 - 1440min) 60

Daylight Saving Time

Daylight Saving Time Disable ▼

Field Name	Description
NTP Enable	Enable/Disable NTP
Option 42	Enable/Disable DHCP option 42. This option specifies a list of the NTP servers available to the client by IP address
Current Time	Display current time
NTP Settings	Setting the Time Zone
Primary NTP Server	Primary NTP server's IP address or domain name
Secondary NTP Server	Options for NTP server's IP address or domain name
NTP synchronization	NTP synchronization cycle, cycle time can be 1 to 1440 minutes in any one, the default setting is 60 minutes

Daylight Saving Time

Table 40 Daylight Saving Time

Daylight Saving Time	
Daylight Saving Time	Enable ▼
Offset	60 Min.
Start Month	April ▼
Start Day of Week	Sunday ▼
Start Day of Week Last in Month	First in Month ▼
Start Hour of Day	2
Stop Month	October ▼
Stop Day of Week	Sunday ▼
Stop Day of Week Last in Month	Last in Month ▼
Stop Hour of Day	2

Procedure

Step 1. Enable Daylight Savings Time.

Step 2. Set value of offset for Daylight Savings Time

Step 3: Set starting Month/Week/Day/Hour in Start Month/Start Day of Week Last in Month/Start Day of Week/Start Hour of Day, analogously set stopping Month/Week/Day/Hour in Stop Month/Stop Day of Week Last in Month/Stop Day of Week/Stop Hour of Day.

Step 4. Press Saving button to save and press Reboot button to active changes.

System Log Setting

Table 41 System log Setting

System Log Setting	
Syslog Setting	
Syslog Enable	Enable ▼
Syslog Level	INFO ▼
Login Syslog Enable	Enable ▼
Call Syslog Enable	Enable ▼
Net Syslog Enable	Enable ▼
Device Management Syslog Enable	Enable ▼
Device Alarm Syslog Enable	Enable ▼
Kernel Syslog Enable	Enable ▼
Remote Syslog Enable	Disable ▼
Remote Syslog Server	

Field Name	Description
Syslog Enable	Enable/Disable syslog function
Syslog Level	Select the system log, there is INFO and Debug two grades, the Debug INFO can provide more information
Remote Syslog Enable	Enable/Disable remote syslog function
Remote Syslog server	Add a remote server IP address
Syslog Enable	Enable/Disable syslog function

Factory Defaults Setting

Table 42 Factory Defaults Setting

Factory Defaults Setting
<p>Factory Defaults Setting</p> <p>Factory Defaults Lock <input type="button" value="Disable ▼"/></p>

Description
When enabled, the device may not be reset to factory defaults until this parameter is reset to Disable

Factory Defaults

Table 43 Factory Defaults

Factory Defaults
<p>Reset to Factory Defaults <input type="button" value="Factory Default"/></p>

Description
Click Factory Default to restore the residential adapter to factory settings

Firmware Upgrade

Table 44 Firmware upgrade

Status	Network	SIP Account	Phone	Administration			
Management	Firmware Upgrade	Scheduled Tasks	Certificates	Provision	SNMP	TR069	

Firmware Management

Firmware Upgrade

Local Upgrade 未选择任何文件

Description

1. Choose upgrade file type from Image File and Dial Rule
2. Press “Browse..” button to browser file
3. Press to start upgrading

Scheduled Tasks

Table 45 Scheduled Tasks

Status	Network	SIP Account	Phone	Administration			
Management	Firmware Upgrade	Scheduled Tasks	Certificates	Provision	SNMP	TR069	

Scheduled Tasks

Scheduled Reboot

Scheduled Reboot ▾

Scheduled Mode ▾

Time ▾ : ▾

Scheduled PPPOE

Scheduled PPPOE ▾

Scheduled Mode ▾

Time ▾ : ▾

Field Name	Description
Scheduled Reboot	

Scheduled Reboot	Enable/Disable scheduled Reboot
Scheduled Mode	Select scheduled Mode
Time	Set the time to restart
Scheduled PPPoE	
Scheduled PPPoE	Enable/Disable scheduled PPPoE
Scheduled Mode	Select scheduled Mode
Time	Set the time to start PPPoE

Provision

Provisioning allows the router to auto-upgrade and auto-configure devices which support TFTP, HTTP and HTTPS .

- Before testing or using TFTP, user should have tftp server and upgrading file and configuring file.
- Before testing or using HTTP, user should have http server and upgrading file and configuring file.
- Before testing or using HTTPS, user should have https server and upgrading file and configuring file and CA Certificate file (should same as https server' s) and Client Certificate file and Private key file

User can upload a CA Certificate file and Client Certificate file and Private Key file in the Security page.

Table 46 Provision

Status	Network	SIP Account	Phone	Administration		
Management	Firmware Upgrade	Scheduled Tasks	Certificates	Provision	SNMP	TR069

Provision	
Configuration Profile	
Provision Enable	Enable ▼
Resync On Reset	Enable ▼
Resync Random Delay(sec)	40
Resync Periodic(sec)	3600
Resync Error Retry Delay(sec)	3600
Forced Resync Delay(sec)	14400
Resync After Upgrade	Enable ▼
Resync From SIP	Disable ▼
Option 66	Enable ▼
Option 67	Enable ▼
Config File Name	\$(MA)
User Agent	
User Name	
Password	
Profile Rule	http://prv1.flyingvoice.net:69/config/\$(MA)?mac=\$(MA)&

Field Name	Description
Provision Enable	Enable provision or not.
Resync on Reset	Enable resync after restart or not
Resync Random	Set the maximum delay for the request of synchronization file. The default is 40
Resync Periodic(sec)	If the last resync was failure, The router will retry resync after the “Resync Error
Resync Error Retry	Set the periodic time for resync, default is 3600s
Forced Resync	If it’ s time to resync, but the device is busy now, in this case,the router will
Resync After	Enable firmware upgrade after resync or not. The default is Enabled
Resync From SIP	Enable/Disable resync from SIP
Option 66	It is used for In-house provision mode only. When use TFTP with option 66 to
Config File Name	It is used for In-house provision mode only. When use TFTP with option 66 to
Profile Rule	URL of profile provision file

Table 47 Firmware Upgrade

Firmware Upgrade

Enable Upgrade	Enable ▾
Upgrade Error Retry Delay (sec)	3600
Upgrade Rule	<input type="text"/>

Field Name	Description
Upgrade Enable	Enable firmware upgrade via provision or not
Upgrade Error Retry Delay(sec)	If the last upgrade fails, the router will try upgrading again after “Upgrade Error Retry Delay” period, default is 3600s
Upgrade Rule	URL of upgrade file

SNMP

Table 48 SNMP

Status	Network	SIP Account	Phone	Administration													
Management	Firmware Upgrade	Scheduled Tasks	Certificates	Provision	SNMP												
<div style="background-color: #cccccc; padding: 2px;">SNMP Configuration</div> <div style="border: 1px solid #ccc; padding: 5px;"> <p>SNMP Configuration</p> <table style="width: 100%; border-collapse: collapse;"> <tr> <td style="width: 50%;">SNMP Service</td> <td style="width: 50%;"><input type="text" value="Disable"/></td> </tr> <tr> <td>Trap Server Address</td> <td><input type="text"/></td> </tr> <tr> <td>Read Community Name</td> <td><input type="text" value="public"/></td> </tr> <tr> <td>Write Community Name</td> <td><input type="text" value="private"/></td> </tr> <tr> <td>Trap Community</td> <td><input type="text" value="trap"/></td> </tr> <tr> <td>Trap period interval(sec)</td> <td><input type="text" value="300"/></td> </tr> </table> </div>						SNMP Service	<input type="text" value="Disable"/>	Trap Server Address	<input type="text"/>	Read Community Name	<input type="text" value="public"/>	Write Community Name	<input type="text" value="private"/>	Trap Community	<input type="text" value="trap"/>	Trap period interval(sec)	<input type="text" value="300"/>
SNMP Service	<input type="text" value="Disable"/>																
Trap Server Address	<input type="text"/>																
Read Community Name	<input type="text" value="public"/>																
Write Community Name	<input type="text" value="private"/>																
Trap Community	<input type="text" value="trap"/>																
Trap period interval(sec)	<input type="text" value="300"/>																

Field Name	Description
SNMP Service	Enable or Disable the SNMP service
Trap Server Address	Enter the trap server address for sending SNMP traps
Read Community Name	String value that is used as a password to request information via SNMP from the device
Write Community Name	String value that is used as a password to write configuration values to the device SNMP
Trap Community	String value used as a password for retrieving traps from the device
Trap period interval(sec)	The interval for which traps are sent from the device

TR-069

TR-069 provides the possibility of auto configuration of internet access devices and reduces the cost of management. TR-069 (short for Technical Report 069) is a DSL Forum technical specification entitled CPE WAN Management Protocol (CWMP). It defines an application layer protocol for remote management of end-user devices. Using TR-069, the terminals establish connection with the Auto Configuration Servers (ACS) and get configured automatically.

Device Configuration using TR-069

The TR-069 configuration page is available under Administration menu.

Table 49 TR069

Status	Network	SIP Account	Phone	Administration			
Management	Firmware Upgrade	Scheduled Tasks	Certificates	Provision	SNMP	TR069	

TR069 Configuration

ACS

TR069 Enable	Enable ▼
CWMP	Enable ▼
ACS URL	http://acs1.flyingvoice.net:8080/tr069
User Name	
Password	
Periodic Inform Enable	Enable ▼
Periodic Inform Interval	3600

Connect Request

User Name	FGW4148-16S
Password	*****

Field Name	Description
ACS parameters	
TR069 Enable	Enable or Disable TR069
CWMP	Enable or Disable CWMP
ACS URL	ACS URL address
User Name	ACS username
Password	ACS password
Periodic Inform	Enable the function of periodic inform or not. By default it is Enabled
Periodic Inform	Periodic notification interval with the unit in seconds. The default value is 3600s
Connect Request parameters	
User Name	The username used to connect the TR069 server to the DUT.
Password	The password used to connect the TR069 server to the DUT.

Diagnosis

In this page, user can do packet trace, ping test and traceroute test to diagnose the device' s connection status.

Table 50 Diagnosis

Description

1. Packet Trace

Users can use the packet trace feature to intercept packets which traverse the device. Click the Start button to start home adapter tracking and keep refreshing the page until the message trace shows to stop, click the Save button to save captured packets.

2. Ping Test

Enter the destination IP or host name, and then click Apply, device will perform ping test.

Ping Test

Ping Test

Dest IP/Host Name

WAN Interface

```
PING www.baidu.com (115.239.210.26): 56 data bytes
64 bytes from 115.239.210.26: seq=0 ttl=54 time=43.979 ms
64 bytes from 115.239.210.26: seq=1 ttl=54 time=53.875 ms
64 bytes from 115.239.210.26: seq=2 ttl=54 time=45.226 ms
64 bytes from 115.239.210.26: seq=3 ttl=54 time=49.534 ms
64 bytes from 115.239.210.26: seq=4 ttl=54 time=49.045 ms

--- www.baidu.com ping statistics ---
5 packets transmitted, 5 packets received, 0% packet loss
round-trip min/avg/max = 43.979/48.331/53.875 ms
```

▲

▼

3. Traceroute Test

Enter the destination IP or host name, and then click Apply, device will perform traceroute test.

Traceroute Test

Traceroute Test

Dest IP/Host Name

WAN Interface

```
traceroute to www.google.com (216.58.208.68), 30 hops max, 38 byte packets
 1 10.110.134.254 (10.110.134.254) 1.017 ms 9.507 ms 1.419 ms
 2 * * *
 3 * * *
 4 * * *
 5 * * *
 6 * * *
 7 * * *
 8 * * *
 9 * * *
10 * * *
.. * * *
```

▲

▼

Operating Mode

Table 51 Operating mode

Status	Network	SIP Account	Phone	Administration						
Management	Firmware Upgrade	Scheduled Tasks	Certificates	Provision	SNMP	TR069	Diagnosis	Operating Mode		
Operating Mode Settings									Help	
Operating Mode Settings										
Operating Mode				Basic Mode ▼						
Description										
Choose the Operation Mode as Basic Mode or Advanced Mode										

System Log

Table 52 System log

Status	Network	SIP Account	Phone	Administration						
Basic	LAN Host	Syslog								
Refresh Clear Save										
<pre> Manufacturer:FLYINGVOICE ProductClass:FGW4148-16S SerialNumber: BuildTime:201609181809 IP:192.168.1.1 HWVer:V1.1 SWVer:V3.11 <Thu Nov 9 15:26:56 2017> admin: 5 admin 0 SW [kworker/u:0] <Thu Nov 9 15:26:56 2017> admin: 6 admin 0 SW [migration/0] <Thu Nov 9 15:26:56 2017> admin: 7 admin 0 SW [migration/1] <Thu Nov 9 15:26:56 2017> admin: 8 admin 0 SW [kworker/1:0] <Thu Nov 9 15:26:56 2017> admin: 9 admin 0 SW [ksoftirqd/1] <Thu Nov 9 15:26:56 2017> admin: 10 admin 0 SW< [khelper] <Thu Nov 9 15:26:56 2017> admin: 11 admin 0 SW [sync_supers] <Thu Nov 9 15:26:56 2017> admin: watchdog.pid </pre>										
Description										
If you enable the system log in Status/syslog webpage, you can view the system log in this webpage.										

Logout

Table 53 Logout



Description

Press the logout button to logout, and then the login window will appear.

Reboot

Press the **Reboot** button to reboot the device.

Chapter 5 IPv6 address configuration

The router devices support IPv6 addressing. This chapter covers:

- [Introduction](#)
- [IPv6 Advance](#)
- [Configuring IPv6](#)
- [Viewing WAN port status](#)
- [IPv6 DHCP configuration for LAN/WLAN clients](#)
- [LAN DHCPv6](#)

Introduction

DHCPv6 protocol is used to automatically provision/configure IPv6 capable end points in a local network. In addition to acquiring an IPv6 IP address for the WAN interface and its associated LAN/WLAN clients, the devices are also capable of prefix delegation.

The Routers devices support the following types of modes of IPv6 addresses:

- Stateless DHCPv6
- Statefull DHCPv6

Table 54 IPv6 Modes

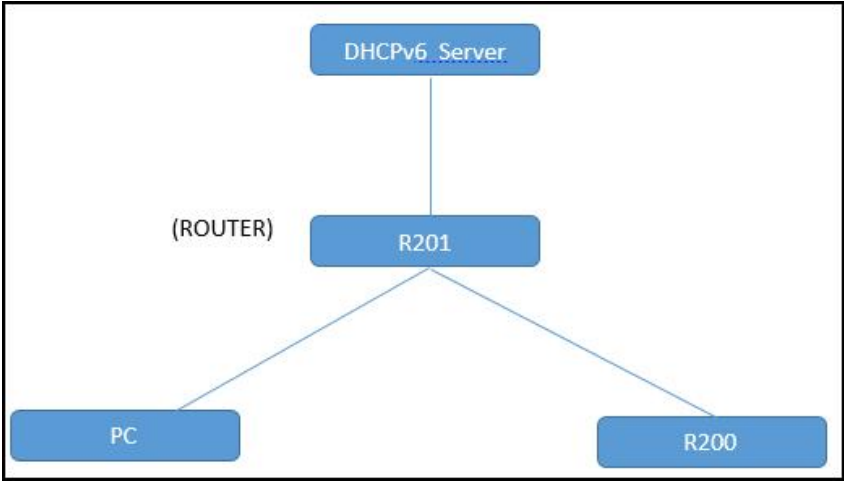
Mode	Description
Stateless	In Stateless DHCPv6 mode, the Routers devices listen for ICMPv6 Router Advertisements messages which are periodically sent out by the routers on the local link or requested by the node using a Router Advertisements solicitation message. The device derives a unique IPv6 address using prefix receives from the router and its own MAC address.
 <pre> graph TD Server[DHCPv6 Server] --- R201[R201] R201 --- PC[PC] R201 --- R200[R200] </pre>	
Statefull	In Statefull DHCPv6 mode, the client works exactly as IPv4 DHCP, in which hosts receive both their IPv6 addresses and additional parameters from the DHCP server.

IPv6 Advance

To enable IPv6 functionality:

Navigate to Network > IPv6 Advanced page.

Select Enable from the IPv6 Enable drop-down list.

Click Save.

Table 55 Enabling IPv6



Type commands, here PC can get the default adapter: fe80::221:f2ff:fe02:1a4f%15.

```

物理地址 . . . . . : F0-DE-F1-C8-96-66
DHCP 已启用 . . . . . : 是
自动配置已启用 . . . . . : 是
本地连接 IPv6 地址 . . . . . : fe80::2db3:666d:88d9:d1c2%15<首选>
IPv4 地址 . . . . . : 192.168.11.90<首选>
子网掩码 . . . . . : 255.255.255.0
获得租约的时间 . . . . . : 2016年2月2日 星期二 上午 10:43:34
租约过期的时间 . . . . . : 2016年2月3日 星期三 上午 10:43:33
默认网关 . . . . . : fe80::221:f2ff:fe02:1a4f%15
                      192.168.11.1
DHCP 服务器 . . . . . : 192.168.11.1
DHCPv6 IAD . . . . . : 368107249
DHCPv6 客户端 DUID . . . . . : 00-01-00-01-1E-0A-7B-28-F0-DE-F1-C8-96-66

DNS 服务器 . . . . . : 192.168.11.1
                      192.168.10.1
TCP/IP 上的 NetBIOS . . . . . : 已启用

```

We can ping through this address.

```

C:\Users\Administrator>ping fe80::221:f2ff:fe02:1a4f%15

正在 Ping fe80::221:f2ff:fe02:1a4f%15 具有 32 字节的数据:
来自 fe80::221:f2ff:fe02:1a4f%15 的回复: 时间=1ms
来自 fe80::221:f2ff:fe02:1a4f%15 的回复: 时间<1ms
来自 fe80::221:f2ff:fe02:1a4f%15 的回复: 时间<1ms
来自 fe80::221:f2ff:fe02:1a4f%15 的回复: 时间<1ms

fe80::221:f2ff:fe02:1a4f%15 的 Ping 统计信息:
    数据包: 已发送 = 4, 已接收 = 4, 丢失 = 0 (0% 丢失),
往返行程的估计时间<以毫秒为单位>:
    最短 = 0ms, 最长 = 1ms, 平均 = 0ms

```

LAN DHCPv6

When IPv6 is enabled, the LAN/WLAN clients of Routers can be configured to receive IPv6 addresses from locally configured IPv6 pool or from an external DHCPv6 server.

To enable LAN DHCPv6 service:

Status	Network	SIP Account	Phone	Administration				
WAN	LAN	IPv6 Advanced	IPv6 WAN	IPv6 LAN	VPN	DMZ	MAC Clone	Port Setting

IPv6 LAN Setting	
IPv6 Address	<input type="text" value="fec0::1"/>
IPv6 Prefix Length	<input type="text" value="64"/> (0-128)
DHCPv6 Server	
DHCPv6 Status	<input type="button" value="Disable"/>
DHCPv6 Mode	<input type="button" value="Stateless"/>
Domain Name	<input type="text"/>
Server Preference	<input type="text" value="255"/> (0-255)
Primary DNS Server	<input type="text"/>
Secondary DNS Server	<input type="text"/>
Lease Time	<input type="text" value="86400"/> (0-86400sec)
IPv6 Address Pool	<input type="text"/> - <input type="text"/> / <input type="text"/>
Router Advertisement	
Router Advertisement	<input type="button" value="Disable"/>
Advertise Interval	<input type="text" value="30"/> (10-1800sec)
RA Managed Flag	<input type="button" value="Disable"/>
RA Other Flag	<input type="button" value="Enable"/>
Prefix	<input type="text"/> / <input type="text"/>
Prefix Lifetime	<input type="text" value="3600"/> (0-3600sec)

Configuring IPv6

Configuring Statefull IPv6

1. Navigate to Network > IPv6WAN page. The following window is displayed:

Stateless mode dhcpv6 client send ipv6 address and DNS request, and the server reply the DNS server and Domain name, and ipv6 address.

The screenshot shows the 'IPv6 LAN Setting' configuration page. The 'DHCPv6 Mode' is highlighted with a red box and set to 'Statefull'. Other settings include IPv6 Address (fec0::1), IPv6 Prefix Length (48), DHCPv6 Server, Domain Name (flyingvoice.com), Server Preference (255), Primary DNS Server (fec0::2), Secondary DNS Server (fec0::3), Lease Time (86400), IPv6 Address Pool (fec0::100 - fec0::200 / 48), Router Advertisement (Enable), Advertise Interval (30), RA Managed Flag (Enable), RA Other Flag (Disable), Prefix, and Prefix Lifetime (3600).

DHCPv6 client configure as this

Table 56 Configuring Statefull IPv6

IPv6 WAN Setting	
Connection Type	DHCPv6
DHCPv6 Address Settings	Stateless
Prefix Delegation	Disable

Field Name	Description
Connection Type	Select connection type
DHCPv6 Address Settings	Set it to statefull mode.
Prefix Delegation	Select Enable.

In this way the Router B can get ipv6 address and DNS address,for more information please check the packets dhcpv6_stateful.pcap.

Also we can check via CLI.

```

Link encap:Ethernet HWaddr 00:21:F2:08:16:59
inet addr:192.168.11.64 Bcast:192.168.11.255 Mask:255.255.255.0
inet6 addr: fec0::100/128 Scope:Site
inet6 addr: fe80::221:f2ff:fe08:1659/64 Scope:Link
UP BROADCAST RUNNING MULTICAST MTU:1500 Metric:1
RX packets:1235 errors:0 dropped:0 overruns:0 frame:0
TX packets:1346 errors:0 dropped:0 overruns:0 carrier:0
collisions:0 txqueuelen:0
RX bytes:103756 (101.3 KiB) TX bytes:1329724 (1.2 MiB)

```

In this mode ,PC can get ipv6 address too.

```

# cat /etc/resolv.conf
nameserver 192.168.11.1
nameserver 192.168.10.1

nameserver fec0::2
nameserver fec0::3

```

```

以太网适配器 本地连接:

   连接特定的 DNS 后缀 . . . . . : flyingvoice.com
   描述 . . . . . : Intel(R) 82579LM Gigabit Network Connection
   物理地址. . . . . : F0-DE-F1-C8-96-66
   DHCP 已启用 . . . . . : 是
   自动配置已启用 . . . . . : 是
   本站点的 IPv6 地址 . . . . . : fec0::101%1<首选>
   获得租约的时间 . . . . . : 2016年2月2日 星期二 上午 11:47:06
   租约过期的时间 . . . . . : 2016年2月3日 星期三 上午 11:47:06
   本地链接 IPv6 地址 . . . . . : fe80::2db3:666d:88d9:d1c2%15<首选>
   IPv4 地址 . . . . . : 192.168.11.90<首选>
   子网掩码 . . . . . : 255.255.255.0
   获得租约的时间 . . . . . : 2016年2月2日 星期二 上午 11:02:22
   租约过期的时间 . . . . . : 2016年2月3日 星期三 上午 11:25:14
   默认网关 . . . . . : fe80::221:f2ff:fe02:1a4f%15
   192.168.11.1
   DHCP 服务器 . . . . . : 192.168.11.1
   DHCPv6 IAID . . . . . : 368107249
   DHCPv6 客户端 DUID . . . . . : 00-01-00-01-1E-0A-7B-28-F0-DE-F1-C8-96

   DNS 服务器 . . . . . : fec0::2%1
   . . . . . : fec0::3%1
   . . . . . : 192.168.11.1
   . . . . . : 192.168.10.1

```

Configuring Stateless IPv6

Stateless mode dhcpv6 client only send DNS request,and the server reply the DNS server and Domain name,DHCPv6 server configure as the picture shows,DHCPv6 client configure as this .



After the configuration,we can check the packets about the dhcpv6 client.For more information,please check dhcpv6_stateless.pcap.

In the router we can check via CLI.But you can not see ipv6 address

```
# cat /etc/resolv.conf
nameserver 192.168.11.1
nameserver 192.168.10.1
nameserver fec0::2
nameserver fec0::3
#
```

ping DNS address

When in stateful mode,device can get ipv6 address from dhcpv6 server,in this way we can ping a dns ,verify if it can do domain name resolve by ipv6 dns address. Check this we can use the packets to prove. You can find on this packet dns.pcap

WAN DHCPv6 client

As I show you with router B, router B use the WAN DHCPv6 client,you can refer to the part 2 to check the stateful and stateless mode.Another thing I need show you is Prefix distribution.

Prefix distribution

- 1)WAN port DHCPv6 server enable prefix distribution feature.
- 2)WAN port DHCPv6 client enable prefix distribution
- 3)LAN port DHCPv6 server disable dhcp service

Topo like this

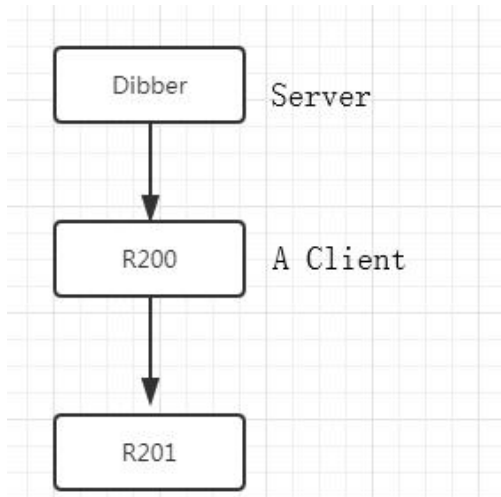

Dibber dhcpv6 server configuration see the attach.

This time I use the stateful mode Router A can get an

ipv6 address ,WAN port and LAN port both can get ipv6 address from the dibbler server.

```

br0    Link encap:Ethernet HWaddr 00:21:F2:02:1A:4F
       inet addr:192.168.11.1 Bcast:192.168.11.255 Mask:255.255.255.0
       inet6 addr: 2001:db8:352e:0:221:f2ff:fe02:1a4f/48 Scope:Global
       inet6 addr: fe80::221:f2ff:fe02:1a4f/64 Scope:Link
       inet6 addr: fec0::1/48 Scope:Site
       UP BROADCAST RUNNING MULTICAST MTU:1500 Metric:1
       RX packets:1255 errors:0 dropped:0 overruns:0 frame:0
       TX packets:1550 errors:0 dropped:0 overruns:0 carrier:0
       collisions:0 txqueuelen:0
       RX bytes:226565 (221.2 KiB) TX bytes:613327 (598.9 KiB)
  
```

The behind router also get an ipv6 address

```

eth2.1 Link encap:Ethernet HWaddr 00:21:F2:08:16:59
       inet addr:192.168.11.64 Bcast:192.168.11.255 Mask:255.255.255.0
       inet6 addr: 2001:db8:352e:0:221:f2ff:fe08:1659/64 Scope:Global
       inet6 addr: fe80::221:f2ff:fe08:1659/64 Scope:Link
       UP BROADCAST RUNNING MULTICAST MTU:1500 Metric:1
       RX packets:693 errors:0 dropped:0 overruns:0 frame:0
       TX packets:563 errors:0 dropped:0 overruns:0 carrier:0
       collisions:0 txqueuelen:0
       RX bytes:58337 (56.9 KiB) TX bytes:375603 (366.7 KiB)
  
```

Use this ipv6 address we can ping Router A LAN ipv6 address

```

C:\Users\Administrator>ping 2001:db8:352e:0:221:f2ff:fe02:1a4f
正在来自来自来自来自 Ping 2001:db8:352e:0:221:f2ff:fe02:1a4f 具有 32 字节的数据:
2001:db8:352e:0:221:f2ff:fe02:1a4f 的回复: 时间<1ms
2001:db8:352e:0:221:f2ff:fe02:1a4f 的回复: 时间<1ms
2001:db8:352e:0:221:f2ff:fe02:1a4f 的回复: 时间<1ms
2001:db8:352e:0:221:f2ff:fe02:1a4f 的回复: 时间<1ms
  
```

Viewing WAN/LAN port status

To view the status of WAN port:

Navigate to Status page.

LAN status

Now only LAN ipv6 dhcpv6 mode is statefull,it can display ipv6 client ipv6 address

Status	Network	Wireless 2.4GHz	Wireless 5GHz	SIP	FXS1	FXS2	Security	Application	Storage	Administration
Basic	LAN Host	Syslog								
LAN Host info										
MAC Address	IP Address	Interface Type	Address Source	Expires	Host name	Status				
00:21:F2:AC:BA:19	192.168.11.207	LAN2	DHCP	23:57:23	cnPilot R201	Active				
00:27:19:95:22:FF	192.168.11.203	LAN3	DHCP	23:57:41	WIN-20151218RLZ	Active				
18:CF:5E:CB:F9:C9	192.168.11.66	FV-TEST	DHCP	23:59:26	MQGAADTGXWBD0ZZ	Active				
IPv6 LAN Host Info										
IPv6 Address										
fec0::100										
fec0::101										

WAN status

Network Status	
Internet Port Status	
Connection Type	DHCP
IP Address	192.168.11.207 <input type="button" value="Renew"/>
Ipv6 Address	fe80::221:f2ff:feac:ba19/64 fec0::100/128
Subnet Mask	255.255.255.0
Default Gateway	192.168.11.1
Primary DNS	192.168.11.1
Secondary DNS	192.168.10.1
Ipv6 Primary DNS	fec0::2
Ipv6 Secondary DNS	fec0::3
WAN Port Status	1000Mbps Full

Chapter 6 Troubleshooting Guide

This chapter covers:

- [Configuring PC to get IP Address automatically](#)
- [Cannot connect to the Web](#)
- [Forgotten Password](#)

Configuring PC to get IP Address automatically

Follow the below process to set your PC to get an IP address automatically:

Step 1 : Click the “Start” button

Step 2 : Select “control panel”, then double click “network connections” in the “control panel”

Step 3 : Right click the “network connection” that your PC uses, select “attribute” and you can see the interface as shown in Figure 3.

Step 4.: Select “Internet Protocol (TCP/IP)”, click “attribute” button, then click the “Get IP address automatically” .

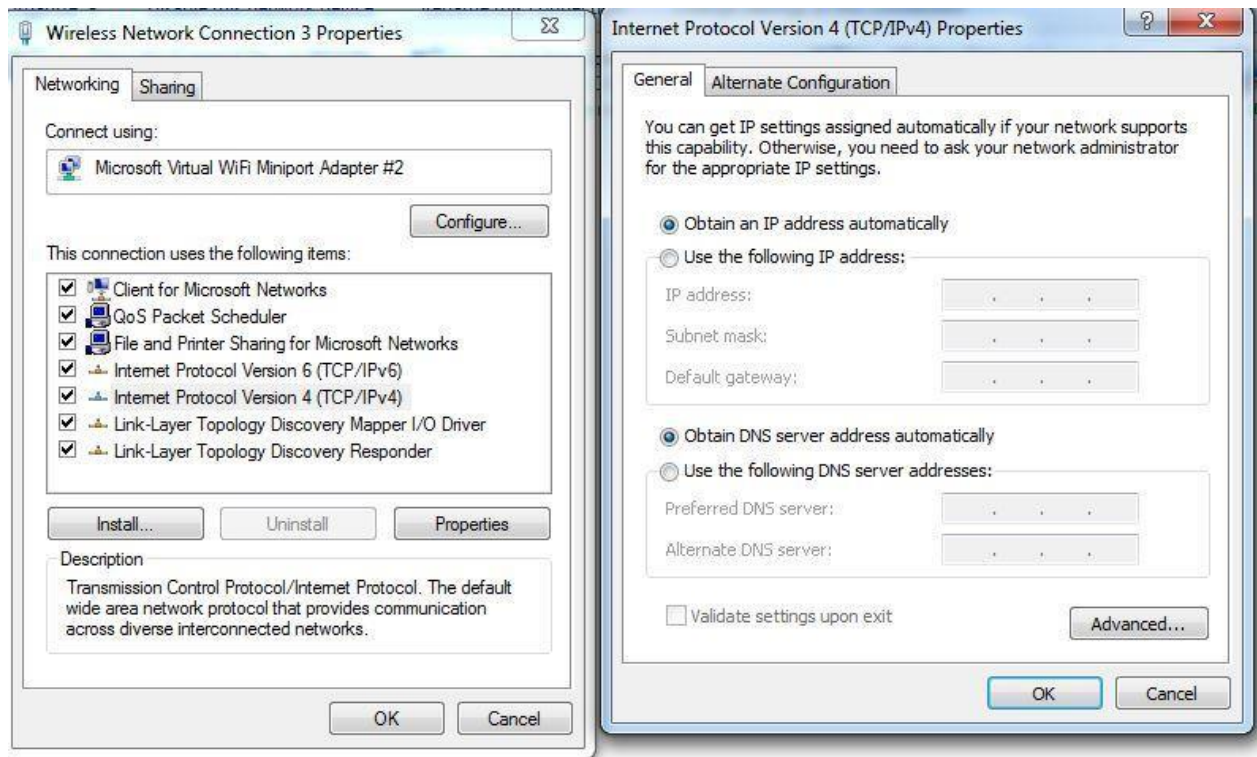

Cannot connect to the Web

Solution:

- Check if the Ethernet cable is properly connected
- Check if the URL is correct. The format of URL is: http:// the IP address
- Check on any other browser apart from Internet explorer such Google
- Contact your administrator, supplier or ITSP for more information or assistance.

Forgotten Password

If you have forgotten the management password, you cannot access the configuration web GUI. Solution:

To factory default: press and hold reset button for 10 seconds.